



GigE VISION CAMERAS

Mako

User Guide

Note: Lenses are not part of this product.

V4.7.3

FW Loader 40118

**Quick links**

- [Mako cameras at a glance](#) on page 15
- [Contact us](#) on page 17
- [Contents](#) on page 18

Read before use

EN - English

Safety

Before using the camera, read these safety instructions. Observe the warnings at all times. Use the camera only as stated in the [Intended use](#) on page 37.

**CAUTION****Risk of burns**

A camera in operation can reach temperature levels which could cause burns.

**CAUTION****Injury by falling cameras or lenses**

A falling camera or lens can cause injury.

**CAUTION****Risk of cuts by sharp edges of lens mounts**

The threads of the lens mount can have sharp edges.

Intended use

Intended use of Allied Vision product is the integration into vision systems by professionals. All Allied Vision product is sold in a B2B setting.

DA - Dansk

Sikkerhed

Læs sikkerhedsanvisningerne, før kameraet bruges. Overhold alle advarsler. Brug kun kameraet som anført i [Intended use](#) på side 37.



FORSIGTIG

Forbrændingsfare

Når kameraet bruges, kan det blive meget varmt og forårsage forbrændinger.



FORSIGTIG

Kvæstelser, hvis kameraet eller linser falder ned

Falder kameraet eller linsen ned, kan dette forårsage kvæstelser.



FORSIGTIG

Fare for snitsår på linsemodulets skarpe kanter

Linsemodulets gevind kan have skarpe kanter.

Tilsigtet brug

Allied Vision produktets tilsigtede brug er en indbygning i et visionssystem, udført af fagfolk. Alle Allied Vision produkter sælges i B2B.

DE - Deutsch

Sicherheit

Bevor Sie die Kamera benutzen, lesen Sie diese Sicherheitshinweise. Beachten Sie diese Hinweise immer. Verwenden Sie die Kamera nur wie beschrieben in [Intended use](#) auf Seite 37.



VORSICHT

Gefahr von Verbrennungen

Im Betrieb kann die Kamera Temperaturen erreichen, die zu Verbrennungen führen.



VORSICHT

Verletzung durch fallende Kameras oder Objektive

Eine fallende Kamera oder ein fallendes Objektiv kann Verletzungen verursachen.



VORSICHT

Schnitte durch scharfkantige Objektivgewinde

Objektivgewinde können scharfe Kanten haben.

Bestimmungsgemäßer Gebrauch

Allied Vision Produkte sind bestimmt für die Integration in Bildverarbeitungssysteme durch Fachpersonal. Alle Allied Vision Produkte werden in einer B2B-Umgebung verkauft.

ES - Español

Seguridad

Antes de utilizar la cámara lea estas instrucciones de seguridad. Observe las advertencias en todo momento. Utilice la cámara solo tal y como se estipula en el [Intended use](#) en la página 37.



ATENCIÓN

Riesgo de quemaduras

Una cámara en funcionamiento puede alcanzar temperaturas que podrían provocar quemaduras.



ATENCIÓN

Lesiones en caso de que las cámaras o las lentes se caigan

Si una cámara o una lente se cae puede provocar lesiones.



ATENCIÓN

Riesgo de cortes debido a los bordes afilados del objetivo

Las roscas de los objetivos pueden tener bordes afilados.

Uso previsto

El uso previsto del producto Allied Vision es la integración en el sistema de visión por parte de profesionales. Todos los productos Allied Vision se venden dentro de una relación B2B.

FI - Suomi

Turvallisuus

Lue nämä turvallisuusohjeet ennen kameran käyttöä. Noudata varoituksia joka hetki. Käytä kameraa ainoastaan kohdassa [Intended use](#) sivulla 37 kuvatulla tavalla.



HUOMIO

Palovammojen vaara

Käytössä olevan kameran saavuttamat lämpötilatasot voivat aiheuttaa palovammoja.



HUOMIO

Putoavien kameroiden tai linssien aiheuttamat vammat

Putoava kamera tai linssi voi aiheuttaa vammoja.



HUOMIO

Linssien kiinnikkeiden terävien reunojen aiheuttamien viiltovammojen vaara

Linssin kiinnikkeiden kierteiden reunat voivat olla teräviä.

Käyttötarkoitus

Allied Vision-tuotteen käyttötarkoitus on integrointi kuvajärjestelmiin ammattilaisten toimesta. Kaikki Allied Vision-tuotteet myydään B2B-ympäristössä.

FR - Français

Sécurité

Veillez lire ces consignes de sécurité avant d'utiliser la caméra. Respectez continuellement les avertissements. Utilisez la caméra uniquement comme indiqué sous [Intended use](#), page 37.



ATTENTION

Risque de brûlures

Une caméra en service peut atteindre des niveaux de température susceptibles d'entraîner des brûlures.



ATTENTION

Blessures en cas de chute de caméras ou d'objectifs

La chute d'une caméra ou d'un objectif peut entraîner des blessures.



ATTENTION

Risque de coupures sur les bords tranchants des montures d'objectif

Les filetages des montures d'objectif peuvent présenter des bords tranchants.

Utilisation prévue

L'utilisation prévue du produit Allied Vision est son intégration dans des systèmes de vision par le soin de professionnels. Tout produit Allied Vision est vendu dans un cadre B2B.

עברית - HE

בטיחות

לפני השימוש במצלמה, עליך לקרוא את הוראות הביטחון האלו. עליך לממש הוראות ביטחון אלו תמיד. השימוש במצלמה הוא רק לפי מה שכתוב ב"כוונת השימוש" (Intended use) בעמוד 37.

זהירות

סכנת כווייה

בזמן הפערת המצלמה עלולות טמפרטורות גבוהות לעלות, שיכולות לגרום לכוויות.



זהירות

פגיעה מנפילת מצלמות או עדשות

מצלמה או עדשה שנופלות עלולות לגרום לפגיעה.



זהירות

סכנה להחתך מתבריג חד של העדשה

תבריג תושבת העדשה עלול להיות חד עד כדי פגיעה.



שימוש מיועד

מוצרי AlliedVision מיועדים לשילוב במערכות ממוחשבת לעיבוד צילומים ע"י אנשי מקצוע. כל מוצרי AlliedVision נמכרים לשימוש בסביבת B2B.

IT - Italiano

Sicurezza

Leggere queste istruzioni per la sicurezza prima di utilizzare la telecamera. Osservare sempre tutte le avvertenze. Utilizzare la telecamera come descritto alla sezione [Intended use](#) a pagina 37.



ATTENZIONE

Pericolo di ustioni

Durante il funzionamento una telecamera può raggiungere temperature elevate che possono essere causa di ustioni.



ATTENZIONE

Lesioni dovute alla caduta di telecamere o lenti

La caduta di una telecamera o di una lente può causare delle lesioni.



ATTENZIONE

Pericolo di tagliarsi sui bordi affilati degli attacchi della lente

I bordi della filettatura dell'attacco della lente possono essere affilati.

Uso previsto

Il prodotto Allied Vision è concepito per essere integrato in sistemi di monitoraggio in campo professionale. Tutti i prodotti Allied Vision sono venduti in uno scenario B2B.

JA - 日本語

安全性

本カメラを使用する前に、この安全の手引きをお読みください。常に、警告事項を守ってください。必ず、[Intended use 37](#) ページの通りに、本カメラを使用してください。



注意

やけどの危険性

作動中のカメラは、やけどを引き起こす温度まで熱くなる恐れがあります。



注意

カメラまたはレンズの落下によるけが

カメラまたはレンズが落下すると、けがをする恐れがあります。



注意

レンズマウントの鋭利な端部で切り傷の危険性

レンズマウントのギザギザの部分が鋭利である可能性があります。

用途

Allied Vision製品は、専門家が視覚装置に統合することを意図したものです。すべてのAllied Vision製品は、企業間取り引き用に販売されています。

NL - Nederlands

Veiligheid

Lees deze veiligheidsinstructies voordat u de camera gaat gebruiken. Neem deze waarschuwingen altijd in acht. Gebruik de camera uitsluitend, zoals aangegeven in het [Intended use](#) op pagina 37.



VOORZICHTIG

Risico van verbranding

Een camera die gebruikt wordt, kan temperatuurwaarden bereiken die brandwonden kunnen veroorzaken.



VOORZICHTIG

Letsel door vallende camera's of lenzen

Een vallende camera of lens kan letsel veroorzaken.



VOORZICHTIG

Risico van snijwonden door scherpe randen van lensbevestigingen

Het schroefdraad van de lensbevestiging kan scherpe randen hebben.

Beoogd gebruik

Het beoogde gebruik van het Allied Vision-product is de integratie in optische systemen door professionals. Alle Allied Vision-producten worden verkocht in de B2B-markt.

NO - Norsk

Sikkerhet

Les disse sikkerhetsinstruksene før du bruker kameraet. Følg advarslene til en hver tid. Bruk kun kameraet i samsvar med [Intended use](#) på side 37.



FORSIKTIG

Risiko for brannskader

Et kamera i bruk kan nå temperaturnivåer som kan forårsake brannskader.



FORSIKTIG

Skade ved fallende kameraer eller linser

Et fallende kamera eller en fallende linse kan forårsake skade.



FORSIKTIG

Risiko for kutt fra skarpe kanter på linsefester

Sporene på linsefestet kan ha skarpe kanter.

Tiltenkt bruk

Den tiltenkte bruken av Allied Vision-produktet er integrering i visjonssystemer av profesjonelle. Alle Allied Vision-produkter selges i en forretning til forretning-situasjon.

SV - Svenska

Säkerhet

Läs igenom säkerhetsinstruktionerna innan du använder kameran. Var hela tiden särskilt uppmärksam på varningarna. Använd enbart kameran på det sätt som anges i [Intended use](#) på sida 37.



VARNING

Risk för brännskada

En kamera i drift kan komma upp i temperaturer som kan orsaka brännskador.



VARNING

Risk för skador från fallande kameror eller objektiv

Fallande kameror eller objektiv kan förorsaka skador.



VARNING

Risk för skärsår från vassa kanter på objektivfattningar

Objektivets gängor kan ha vassa kanter.

Avsedd användning

Den avsedda användningen av Allied Vision-produkter är integrering i visionssystem av fackmän. Samtliga Allied Vision-produkter säljs i en B2B-miljö.

ZH - 简体中文版

安全需知

使用本相机前，请阅读本安全说明书。请务必遵守相关警告和 [Intended use](#) 于第 37 页。



注意事项

烫伤风险

相机操作过程中温度可能上升并导致烫伤风险。



注意事项

相机或者镜头跌落造成伤害

相机或者镜头可能会跌落并造成伤害。



注意事项

镜头接口的锐利边缘划伤风险

镜头接口螺纹边缘可能较为锐利。

预期用途

Allied Vision 产品的预期用途是由专业人士整合到视觉系统中。所有 Allied Vision 的产品均通过 B2B 渠道销售。

Mako cameras at a glance



Get an overview of Mako camera documentation.

Read this manual carefully

Learn how to protect your camera from damage and fully understand its functions.

Mako is Allied Vision's ultra-compact format AIA GigE Vision compliant camera. Mako models incorporate high quality CCD or CMOS sensors from Sony, ON Semi, Teledyne e2v, and CMOSIS/ams.

Mako cameras are offered with either a C-Mount or CS-Mount to support a wide range of lenses. An M12-Mount (S-Mount) adapter is also available.

Scope of delivery

Your Allied Vision camera is delivered with the following components:

- Mako GigE Vision camera
- Download Instructions

What else do you need?

Content	URL
GigE Features Reference, camera data sheets, Modular Concept, and 3D CAD STEP files	www.alliedvision.com/en/support/technical-documentation/mako-g-documentation
Application notes	www.alliedvision.com/en/support/faqs-application-notes
Camera lenses and accessories	www.alliedvision.com/en/products/accessories
Download Vimba and software tools	www.alliedvision.com/en/support/software-downloads
Download the latest GigE firmware loader and release notes.	www.alliedvision.com/en/support/firmware-downloads
For details about camera warranty duration and sensor warranty terms.	www.alliedvision.com/en/support/warranty

Table 1: Additional resources

Contact us

Website, email

General

www.alliedvision.com/en/contact

info@alliedvision.com

Distribution partners

www.alliedvision.com/en/avt-locations/avt-distributors

Support

www.alliedvision.com/en/support

www.alliedvision.com/en/about-us/contact-us/technical-support-repair-/-rma

Offices

Europe, Middle East, and Africa (Headquarters)

Allied Vision Technologies GmbH
Taschenweg 2a
07646 Stadtroda, Germany
T// +49 36428 677-0 (Reception)
T// +49 36428 677-230 (Sales)
F// +49 36428 677-28

North, Central, and South America, Canada

Allied Vision Technologies Canada Inc.
300 – 4621 Canada Way
Burnaby, BC V5G 4X8, Canada
T// +1 604 875 8855

USA

Allied Vision Technologies, Inc.
102 Pickering Way- Suite 502
Exton, PA 19341, USA
Toll-free// +1-877-USA-1394
T// +1 978 225 2030

Asia-Pacific

China

Allied Vision Technologies Shanghai Co Ltd.
B-510, Venture International Business Park
2679 Hechuan Road
Minhang District, Shanghai 201103
People's Republic of China
T// +86 21 64861133

Japan

Allied Vision Technologies
Yokohama Portside Bldg. 10F
8-1 Sakae-cho, Kanagawa-ku
Yokohama-shi, Kanagawa, 221-0052
T// +81 (0) 45 577 9527

Singapore

Allied Vision Technologies Asia Pte. Ltd
82 Playfair Rd, #07-01 D'Lithium
Singapore 368001
T// +65 6634 9027

Contents

Read before use	2
EN - English	2
DA - Dansk	3
DE - Deutsch	4
ES - Español	5
FI - Suomi	6
FR - Français	7
HE - עברית	8
IT - Italiano	9
JA - 日本語	10
NL - Nederlands	11
NO - Norsk	12
SV - Svenska	13
ZH - 简体中文版	14
Mako cameras at a glance	15
Scope of delivery	16
What else do you need?	16
Contact us	17
Document history and conventions	23
Document history	24
Manual conventions	30
Typographic styles	30
Product naming	32
Acronyms and terms	32
Compliance, safety, and intended use	34
Compliance notifications	35
For customers in Canada	36
Pour utilisateurs au Canada	36
Avoid electromagnetic interferences	36
Intended use	37
Copyright and trademarks	37
Your safety	38
Handling lens mounts	38
Handling hot cameras	38
Providing optimum heat dissipation	38
Camera mounting	39
Product safety	40
Electrical connections	40
Optical components	41
Specifications	42

Applied standards	43
GigE Vision	43
GenICam	43
IP class	43
Shock and vibration	43
Notes on specifications	44
Dimensions and mass	44
Frame memory	44
Resolution and ROI frame rate	44
Absolute QE plots	45
Spectral response plots	46
Specifications common to all models	47
Hardware options	47
Mako G-032	48
Absolute QE	49
Spectral response	49
ROI frame rate	50
Mako G-040	51
Absolute QE	53
Spectral response	53
ROI frame rate	54
Mako G-125	55
Absolute QE	56
Spectral response	56
ROI frame rate	57
Mako G-131	58
Absolute QE	60
Spectral response	60
ROI frame rate	61
Mako G-158	62
Absolute QE	64
Spectral response	64
ROI frame rate	65
Mako G-192	66
Absolute QE	68
Spectral response	68
ROI frame rate	69
Mako G-223	70
Absolute QE	71
Spectral response	71
ROI frame rate	72
Mako G-234	73
Absolute QE	75
Spectral response	75
ROI frame rate	76
Mako G-319	78
Absolute QE	80
Spectral response	80

ROI frame rate.....	81
Mako G-419.....	82
Absolute QE.....	83
Spectral response.....	84
ROI frame rate.....	85
Mako G-507.....	86
Absolute QE.....	88
Spectral response.....	88
ROI frame rate.....	89
Mako G-508B POL.....	90
Absolute QE.....	91
Relative spectral response.....	91
Polarization coding diagram.....	92
ROI frame rate.....	93
Mako G-511.....	94
Absolute QE.....	96
Spectral response.....	96
ROI frame rate.....	97
Mako G-811.....	98
Absolute QE.....	100
Spectral response.....	100
ROI frame rate.....	101
Mako G-1242.....	102
Absolute QE.....	104
Spectral response.....	104
ROI frame rate.....	105
Camera feature availability.....	106
Mechanical dimensions.....	108
C-Mount (default).....	108
CS-Mount.....	108
M12-Mount (S-Mount).....	109
Tripod adapter.....	109
Sensor position accuracy.....	110
Lens protrusion for different mounts.....	111
C-Mount with 22 mm filter (default).....	111
CS-Mount with 22 mm filter.....	112
M12-Mount (S-Mount) with 22 mm filter.....	112
C-Mount with 16 mm filter.....	112
CS-Mount with 16 mm filter.....	113
M12-Mount (S-Mount) with 16 mm filter.....	113
Dimensional adjustment.....	113
Filter and lenses.....	114
Focal length vs. field of view.....	115
Mako G-032.....	115
Mako G-040.....	116
Mako G-131.....	116
Mako G-158.....	117
Mako G-192.....	117

Mako G-223	118
Mako G-234	118
Mako G-319	119
Mako G-419	119
Mako G-507	120
Mako G-508B POL	120
Mako G-511	121
Mako G-811	121
Mako G-1242	122
Optical filters	123
Installing the camera	124
Touching hot cameras	125
Electrostatic discharge	125
Mounting the camera	126
Adapting maximum torque values	127
Mounting the lens	128
Lens load	129
Configuring the host computer	129
Installing the NIC driver	130
IP settings	130
Optimize system performance	131
Enabling jumbo packets	131
Connecting your camera	132
Powering up the camera	132
Powering the camera via Hirose I/O port	133
Powering the camera via PoE	133
Connecting to host application	134
Allied Vision software	134
Third-party software	135
Configuring your camera	135
Accessories	135
Camera interfaces	136
Back panel	137
Status LEDs	137
Gigabit Ethernet port	138
Camera I/O connections	138
Output block diagram	141
Control signals	143
Input block diagram	143
Output signals	144
Camera trigger	145
Trigger timing diagram	145
Trigger definitions	146
Trigger rules	146
Triggering during the idle state	147
Triggering during the readout state	147

Image data flow	148
Mako models with CCD sensors	149
Mako G-032 and G-125	149
Mako models with CMOS sensors	150
Mako G-131 and G-192	150
Mako G-223 and G-419	151
Mako G-040, G-158, G-234, G-319, G-507, G-508B POL, G-511, G-811, and G-1242	152
Color interpolation (Bayer demosaicing)	153
Cleaning optical components	155
Keeping optical components clean	156
Identifying impurities	157
Locating impurities	157
Removing the IR cut filter	158
Materials for cleaning optical components	159
Cleaning Instructions	160
Cleaning with compressed air	161
Firmware update	162
Index	165

Document history and conventions



This chapter includes:

Document history	24
Manual conventions.....	30

Document history

Version	Date	Remarks
V4.7.3	2024-Nov-07	Firmware loader: 40118 Corrected typos.
V4.7.2	2024-Jul-16	Firmware loader: 40118 Applied editorial changes.
V4.7.1	2024-Jun-18	Firmware loader: 40118 Updated the addresses of Sales offices in Contact us on page 17.
V4.7.0	2024-May-17	Release: Firmware loader: 40118 <ul style="list-style-type: none"> Removed data for discontinued Mako G-503 model. Updated descriptions in Status LEDs on page 137. Applied editorial changes.
V4.6.5	2024-Feb-06	<ul style="list-style-type: none"> Changed reference from FW versions to FW Loader versions on the title page and in this table. Updated contents in IP settings on page 130.
V4.6.4	2023-Oct-02	<ul style="list-style-type: none"> Added note for QE curve and updated relative response curve for Mako G-508B POL on page 90. Applied editorial changes.
V4.6.3	2023-Jul-10	<ul style="list-style-type: none"> Applied editorial changes.
V4.6.2	2023-Jan-27	<ul style="list-style-type: none"> Added note that lenses are not part of the product. Updated Hebrew contents in Read before use on page 2.
V4.6.1	2022-Oct-20	Release: Firmware loader: 40111 <ul style="list-style-type: none"> Added firmware versions for better orientation. Updated values for exposure times and increments in Specifications on page 42 onwards for Mako G-040, G-158, G-234, G-319, G-507, G-508 models. Applied editorial changes.
V4.6.0	2022-Aug-22	Release: Firmware loader: 39784 <ul style="list-style-type: none"> Renamed the document from Technical Manual to User Guide. Added Hebrew contents to Read before use on page 2. Moved Installing the camera on page 124 behind Filter and lenses on page 114. Updated IR cut filter curve in Optical filters on page 123. Applied editorial changes.
V4.5.3	2021-Dec-08	<ul style="list-style-type: none"> Applied editorial changes.
V4.5.2	2021-Nov-10	Release: Firmware loader: 37388 Updated data in tables for Camera feature availability on page 106.
V4.5.1	2021-Oct-18	<ul style="list-style-type: none"> Updated dimension value in technical drawings for Lens protrusion for different mounts on page 111. Applied editorial changes.

Table 2: Document history (sheet 1 of 7)

Version	Date	Remarks
V4.5.0	2021-Sep-16	<ul style="list-style-type: none"> Updated Mounting the camera on page 126. Added data for new Mako G-511, G-811, and G-1242 models to Specifications on page 42 and Focal length vs. field of view on page 115. Corrected availability for binning with color models for Mako G-507 on page 86. Updated dimension value in technical drawings for Lens protrusion for different mounts on page 111. Applied editorial changes.
V4.4.7	2021-Aug-19	<ul style="list-style-type: none"> Added icon for compliance with UKCA in Compliance notifications on page 35. Applied editorial changes.
V4.4.6	2021-Jul-13	<p>Release: Firmware loader: 34365</p> <ul style="list-style-type: none"> Updated QE and spectral response plots for Mako G-223, G-449, and G-419 NIR in Specifications on page 42. Removed references to discontinued model: Mako G-030. Removed references to discontinued model: Mako G-223B NIR. Applied editorial changes.
V4.4.5	2020-Jun-05	<p>Release: Firmware loader: 29320</p> <ul style="list-style-type: none"> Added Read before use on page 2. Added Your safety on page 38. Added Product safety on page 40. Added order codes for new power supplies. Added time between exposure values for Mako G-032, G-125, G-131, G-192, G-223, G-419, and G-503. Updated Installing the camera on page 124. Applied editorial changes.
V4.4.4	2020-Jan-20	<ul style="list-style-type: none"> Updated Intended use on page 37. Updated Compliance notifications on page 35. Added heavy lens information. Applied editorial changes.
V4.4.3	2019-Aug-25	<ul style="list-style-type: none"> IEEE 1588 Precision Time Protocol (PTP) and Trigger over Ethernet (ToE) Action Commands features are added to Mako G-223 and G-419. Changed the IR cut filter section to Optical filters and included all optical filters available for the Mako camera family. Corrected Canadian ICES compliance statement. Updated technical drawings. Added content to Mounting the camera section. Applied editorial changes.

Table 2: Document history (sheet 2 of 7)

Version	Date	Remarks
V4.4.2	2019-Mar-08	<ul style="list-style-type: none"> Initial commercial release: Mako G-508B POL on page 90 <ul style="list-style-type: none"> Sony IMX250MZR CMOS sensor. Specifications, chief ray angle, absolute QE, ROI frame rate Added shock and vibration information. Added color interpolation content to Image Data Flow chapter. Applied editorial changes.
V4.4.1	2019-Jan-31	<ul style="list-style-type: none"> IEEE 1588 Precision Time Protocol (PTP) and Trigger over Ethernet (ToE) Action Commands features are added to Mako G-040, G-158, G-234, G-319, and G-507 with firmware version 01.54.21000. Updated Mako G-040, G-158, G-234, G-319, and G-507 specifications (firmware version 01.54.20343), see the GigE Firmware Release Notes for details of the changes. Added trigger latency and trigger jitter values for Mako G-223 and G-419 Corrected Mako G-040 streamhold capacity value. Added content to installation chapter: Powering the camera via PoE Corrected Mako 2D technical drawings. Corrected lens mount cross section drawings. Added Mounting the camera to Hardware and Installation chapter. Added Supplier Declaration of Conformity to Compliance and intended use chapter. Added camera electronics damage notice table to Installation and hardware chapter. Applied various other minor enhancements and corrections
V4.4.0	2018-Jul-11	<ul style="list-style-type: none"> Initial commercial release: Mako G-040 on page 51 with: <ul style="list-style-type: none"> Sony IMX287 CMOS sensor Specifications, chief ray angle, absolute QE, spectral response, ROI frame rate. Initial commercial release: Mako G-158 on page 62 with: <ul style="list-style-type: none"> Sony IMX273 CMOS sensor Specifications, chief ray angle, absolute QE, spectral response, ROI frame rate. Updated installation chapter. Updated symbols used in this manual. Updated RoHS statement to include amendment 2015/863/EU. Added abbreviations and acronyms used in this manual. Applied various other minor enhancements and corrections.
V4.3.3	2017-Dec-11	<ul style="list-style-type: none"> Added Removing IR cut filter section to cleaning chapter. Added Specifications common to all models to simplify the model specific tables. Simplified the Contact us section, click the link to find contact information for your region or email us at one of the provided email addresses. Applied various other minor enhancements and corrections.

Table 2: Document history (sheet 3 of 7)

Version	Date	Remarks
V4.3.2	2017-Jul-31	<ul style="list-style-type: none"> Mako G-223 and G-419: Removed RGBA8Packed and BGRA8Packed pixel formats. Mako G-234: Added Mono12 and Mono12Packed. Corrected user trigger pulse statement. Updated camera images to reflect the new black powder coating housing. For more information, see PCN-2017-03-05. CMOSIS renamed to CMOSIS/ams following the acquisition of CMOSIS by ams Sensors Belgium. e2v renamed to Teledyne e2v following the acquisition of e2v by Teledyne Technologies Inc. Corrected user trigger rules. Corrected exposure control values for Mako G-223 Updated technical drawing. Updated camera dimensions in specification tables. Changed cell size terminology to pixel size.
V4.3.1	2017-Apr-07	<ul style="list-style-type: none"> Added cable color to camera I/O connector pin assignment including pin assignment figure and cross reference to the Allied Vision I/O cable data sheet.
V4.3.0	2017-Mar-13	<ul style="list-style-type: none"> Added Piecewise Linear HDR option to Exposure Mode for the Mako G-223 and G-419. For more information, see the GigE Features Reference. Applied various minor corrections.
V4.2.3	2016-Dec-21	<ul style="list-style-type: none"> Added missing absolute QE plots for NIR wavelength (Mako G-419B NIR).
V4.2.2	2016-Nov-23	<ul style="list-style-type: none"> BinningHorizontalMode and BinningVerticalMode options Sum and Average are supported by Mako G-131, G-192, and G-503. Updated the absolute QE plot and added a spectral response plot for the Mako G-032.
V4.2.1	2016-Nov-08	<ul style="list-style-type: none"> Corrected typographic issues. Corrected Mako G-503 shutter type.
V4.2.0	2016-Nov-07	<ul style="list-style-type: none"> Initial commercial release: Mako G-319 on page 78 with: <ul style="list-style-type: none"> - Sony IMX265 CMOS sensor - Specifications, absolute QE, spectral response, ROI frame rate information, camera lens information, and image data flow. Added missing information in specification tables.

Table 2: Document history (sheet 4 of 7)

Version	Date	Remarks
V4.1.0	2016-Oct-12	<ul style="list-style-type: none"> • Initial commercial release: Mako G-507 on page 86 with: <ul style="list-style-type: none"> - Sony IMX264 CMOS sensor - Specifications, absolute QE, spectral response, ROI frame rate information, camera lens information, and image data flow. • Added a tripod adapter warning message. • Updated absolute QE plots for models with Sony sensors. • Added spectral response plots for models with Sony sensors. • Added optical filter information to specification tables. • Added overlapping trigger note for Mako G-131 and G-192 in Specifications chapter and Camera interfaces chapter. • Updated image flow diagrams. • Updated Mako G-234 specifications. • Added 10-bit, 12-bit switchability to Mako G-234.
V4.0.0	2015-Nov-24	<ul style="list-style-type: none"> • Changed the technical manual layout. • Changed chapter name from Camera data path to Image data flow. • Changed chapter name from Camera dimensions to Mechanical dimensions. • Merged the Resolution and ROI frame rate chapter of V3.2.0 into Specifications chapter. • Added Mako at a glance section. • Added General safety notes section. • Added Regulations section in Safety and regulations chapter to replace Legal notice and Safety and regulations sections in V3.2.0. • Moved Sensor position accuracy section from Appendix to Mechanical dimensions chapter. • Added Cleaning optical components chapter to replace Camera cleaning section of V3.2.0. • Added Contact us section to replace Contacting Allied Vision section of V3.2.0. • Deleted Appendix. • Added Camera feature comparison section in Specifications chapter to replace Camera smart features and Camera features sections in V3.2.0 • Added Cross section: C-Mount and CS-Mount section to replace Cross section: <ul style="list-style-type: none"> - C-Mount and Cross section: CS-Mount sections in V3.2.0. • Initial commercial release: Mako G-234 on page 73 with: <ul style="list-style-type: none"> - Sony IMX249 CMOS sensor - Specifications, absolute QE, spectral response, ROI frame rate information, camera lens information, and image data flow. • Removed references to Mako G-050 and G-095. The last time shipment period ends on December 31, 2015 as detailed in PCN 2015-05-03. • Updated Camera Interfaces chapter.
V3.2.0	2015-Mar-20	<ul style="list-style-type: none"> • Replaced old links with new Allied Vision website links. • Changed file name from GigE Camera and Driver Features to GigE Features Reference.

Table 2: Document history (sheet 5 of 7)

Version	Date	Remarks
V3.1.0	2015-Mar-10	<ul style="list-style-type: none"> Initial commercial release: Mako G-507 on page 86 with: <ul style="list-style-type: none"> - ON Semi MT9P031/MT9P006 CMOS sensor - Specifications, absolute QE, ROI frame rate information, camera lens information, and image data flow. Added camera lens information. Added ROI frame rate section. Updated Image data flow and Mechanical dimensions chapters.
V3.0.0	2015-Jan-15	<ul style="list-style-type: none"> Initial commercial release: The following table provides specifications common to all Mako models. on page 47 with: <ul style="list-style-type: none"> - CMOSIS/ams CMV300 CMOS sensor - Specifications, absolute QE, ROI frame rate information, camera lens information, and image data flow. Initial commercial release: Mako G-131 on page 58 with: <ul style="list-style-type: none"> - Teledyne e2v EV76C560 CMOS sensor - Specifications, absolute QE, ROI frame rate information, camera lens information, and image data flow. Initial commercial release: Mako G-192 on page 66 with: <ul style="list-style-type: none"> - Teledyne e2v EV76C570 CMOS sensor - Specifications, absolute QE, ROI frame rate information, camera lens information, and image data flow. Updated Allied Vision logo. Updated Cleaning optical components chapter. Updated Mako camera smart features table. Added camera lens information. Added ROI frame rate, ROI frame rate, and ROI frame rate sections. Updated Image data flow and Mechanical dimensions chapters.
V2.1.0	2014-Oct-07	<ul style="list-style-type: none"> Updated and rearranged Notes on specifications section. Added Camera features comparison. Added trigger latency and jitter values for Mako G-032 and G-125. Updated Mako standard housing drawing. Updated Mako G-503C section. Added camera lens information. Updated image data flow and mechanical dimensions chapters.
V2.0.4	2014-Feb-28	<ul style="list-style-type: none"> Updated available color pixel formats for Mako G-223 and G-419. Updated optional accessories in the Notes on specifications section. Updated section Cross section: C-Mount and CS-Mount. Added section Heat dissipation. Updated the operating temperature specification for Mako G-032, G-125, G-223, and G-419. Updated block diagrams in Image data flow to remove the RS232 reference. Added Hirose cable information.

Table 2: Document history (sheet 6 of 7)

Version	Date	Remarks
V2.0.3	2013-Nov-27	<ul style="list-style-type: none"> Updated gain control values for Mako G-223 and G-419. Updated Status LED 2 table. Updated the note on StreamHoldCapacity in Notes on specifications and frame memory sections. Updated block diagrams in Image data flow chapter. Updated the Index.
V2.0.2	2013-Sep-16	<ul style="list-style-type: none"> Updated the frame rate information for Mako G-223 and G-419 in the Specifications chapter. Updated introduction to include link to Mako documentation webpage. Updated Status LEDs section. Added captions to tables in camera lenses section. Added links to GigE Camera and Driver Features document.
V2.0.1	2013-Sep-11	<ul style="list-style-type: none"> Added table of contents. Added camera cleaning chapter. Updated the specifications for Mako G-223 and G-419.
V2.0.0	2013-Aug-30	<ul style="list-style-type: none"> New manual release status

Table 2: Document history (sheet 7 of 7)

Manual conventions

To give this manual an easily understood layout and to emphasize important information, the following typographical styles and symbols that are used.

Typographic styles

Style (example)	Function
Emphasis	Programs, or highlighting important things.
Feature names	GigE features names are displayed as monospaced text.
<i>Feature options</i>	Features options and register's options that are selectable by the user are displayed as monospaced italicized text.
UI Element	Text that is displayed, or output, by the system for the user, like parts of the GUI, dialog boxes, buttons, menus, important information, windows titles.
Web Reference	References to other documents or webpages, like web links, hypertext links, emails, but also cross references, that include a link the user can follow by clicking.

Table 3: Typographic styles

Symbols and notes



CAUTION

Risk of burns

Precautions are described



CAUTION

Injury by falling cameras or lenses

Precautions are described



CAUTION

Risk of cuts by sharp edges of lens mounts

Precautions are described



NOTICE

Material damage

Precautions are described.



NOTICE

Material damage by electrostatic discharge (ESD)

Precautions as described.



Avoiding malfunctions

Precautions are described.



Practical tip

Additional information helps to understand or ease handling the camera.



Additional information

Web address or reference to an external source with more information is shown.

Product naming

Names of third-party products in this document are shortened to ease reading. Nevertheless, we respect all manufacturer rights and trademarks.

Official product name	Naming in this document	Manufacturer website
Sony Semiconductor Solutions	Sony	www.sony-semicon.co.jp/
ON Semiconductor	ON Semi	www.onsemi.com/
ams Sensors Belgium	CMOSIS/ams	www.cmosis.com/
Teledyne e2v	Teledyne e2v	www.e2v.com/

Table 4: Third-party product naming

Acronyms and terms

The following table provides a list of acronyms and terms used in this manual.

Acronym or term	Description
ADC	Analog to Digital Converter
AIA	Automated Imaging Association
CCD	Charge-coupled device
CMOS	Complementary metal-oxide semiconductor
EMI	Electromagnetic Interference
EMVA	European Machine Vision Association
ESD	Electrostatic discharge
FIFO	First-in first-out
GigE	Gigabit Ethernet
GND	Ground (power)
GVSP	GigE Vision Streaming Protocol
H × V	Horizontal × Vertical (sensor resolution measurement)
LUT	Look-up table
MSDS	Material Safety Data Sheet
NIC	Network interface card
NIR	Near-Infrared
PoE	Power over Ethernet
QE	Quantum efficiency
RoHS	Restriction of Hazardous Substances Directive

Table 5: Acronyms and terms used in this manual (sheet 1 of 2)

Acronym or term	Description
ROI	Region of interest
SDK	Software Development Kit
SFNC	Standard Feature Naming Convention
t_{pdHL}	Propagation delay high-to-low

Table 5: Acronyms and terms used in this manual (sheet 2 of 2)

Compliance, safety, and intended use



This chapter includes:

Compliance notifications	35
Intended use	37
Copyright and trademarks	37
Your safety.....	38
Product safety	40

Compliance notifications



National regulations on disposal must be followed.

For customers in the US



Class B digital device

Note: This equipment has been tested and found to comply with the limits for a Class B digital device, pursuant to part 15 of the FCC Rules. These limits are designed to provide reasonable protection against harmful interference in a residential installation. This equipment generates, uses and can radiate radio frequency energy and, if not installed and used in accordance with the instructions, may cause harmful interference to radio communications. However, there is no guarantee that interference does not occur in a particular installation. If this equipment does cause harmful interference to radio or television reception, which can be determined by turning the equipment off and on, the user is encouraged to try to correct the interference by one or more of the following measures:

- Reorient or relocate the receiving antenna.
- Increase the separation between the equipment and receiver.
- Connect the equipment into an outlet on a circuit different from that to which the receiver is connected.
- Consult the dealer or an experienced radio/TV technician for help.

We caution the user that changes or modifications not expressly approved by the party responsible for compliance could void the user's authority to operate the equipment.

Supplier Declaration of Conformity

Mako cameras comply with Part 15 of the FCC Rules. Operation is subject to the following two conditions:

1. This device may not cause harmful interference, and
2. This device must accept any interference received, including interference that may cause undesired operation.

Party issuing Supplier's Declaration of Conformity

Allied Vision Technologies GmbH
Taschenweg 2a
07646 Stadtroda, Germany
T// +49 (36428) 677-106
quality@alliedvision.com

Responsible party - US contact information

Allied Vision Technologies, Inc.
102 Pickering Way – Suite 502
Exton, PA 19341, USA
T// +1 978 225 2030

Note: changes or modifications not expressly approved by the party responsible for compliance could void the user's authority to operate the equipment.

For customers in Canada

This apparatus complies with the Class B limits for radio noise emissions set out in the Radio Interference Regulations.

CAN ICES-3 (B) / NMB-3 (B)

Pour utilisateurs au Canada

Cet appareil est conforme aux normes classe B pour bruits radioélectriques, spécifiées dans le Règlement sur le brouillage radioélectrique.

CAN ICES-3 (B) / NMB-3 (B)

Avoid electromagnetic interferences

For all power and interface connections, only use shielded cables or cables recommended by Allied Vision.

Intended use

Allied Vision's objective is the development, design, production, maintenance, servicing and distribution of digital cameras and components for image processing. We are offering standard products as well as customized solutions.

Intended use of Allied Vision product is the integration into Vision systems by professionals. All Allied Vision product is sold in a B2B setting.

Allied Vision isn't a legal manufacturer of medical product. Instead, Allied Vision cameras and accessories may be used as components for medical product after design-in by the medical device manufacturer and based on a quality assurance agreement (QAA) between Allied Vision (supplier) and medical device manufacturer (customer). Allied Vision's duties in that respect are defined by ISO 13485, clause 7.2 (customer-related processes, equivalent to ISO 9001, clause 8.2).

Copyright and trademarks

All text, pictures, and graphics are protected by copyright and other laws protecting intellectual property. All content is subject to change without notice.

All trademarks, logos, and brands cited in this document are property and/or copyright material of their respective owners. Use of these trademarks, logos, and brands does not imply endorsement.

Copyright © 2024 Allied Vision GmbH. All rights reserved.

Your safety

This section informs about issues related to your personal safety. Descriptions explain how to avoid hazards and operate Mako cameras safely.

Handling lens mounts

The lens mount thread has sharp edges. Be careful these edges do not cut your skin when mounting or unmounting lenses.

Handling hot cameras

If you hold the camera in your hands during operation, your skin may get hurt. If you touch the camera when it is heated up, we recommend wearing protective gloves.

Providing optimum heat dissipation

Operation outside the allowed temperature range can damage the camera. For best performance and to protect the camera from damage, keep the housing temperature in the specified operating temperature range.

Observe the following:

- To avoid camera crashes, operate the camera with a lens or lens adapter attached only.
- For maximum heat dissipation, affix the camera to a heat sink, using the mounting holes.
- Use mounting base and heat sink with large surface areas.
- Use a mounting base with a high thermal conductivity.
- Reduce ambient temperature. For example, in an outdoor application with direct sunlight, provide shading by an enclosure.
- Provide ventilation or other active cooling of camera, mounting base, and heat sink.

Camera mounting

Mako cameras must be mounted using the mounting threads. If vibration is higher than specified, cameras can disconnect from the mounting. Falling cameras can hurt you. To avoid personal injury:

- Mount the camera according to the instructions in the installation chapter.
- Ensure, shock and vibration do not exceed the specified range as specified in the specifications chapter.
- For heavy or long lenses, use a lens support and apply tests.

Lens load

For non-static applications, use lenses with a mass less than 140 grams and a length less than 38 mm, where the center of gravity is 20 mm, measured from the lens mount front flange. For heavier or longer lenses, use a lens support and apply additional tests. For more information, please contact support at www.alliedvision.com/en/about-us/contact-us/technical-support-repair-/-rma.

Product safety

To prevent material damage, read the following to understand how to safely handle and operate the camera.

Electrical connections

ESD

ESD is dangerous for electronic devices, especially when tools or hands get in contact with connectors. We recommend measures to avoid damage by ESD:

- **Unpacking:** Remove the camera from its anti-static packaging only when your body is grounded.
- **Workplace:** Use a static-safe workplace with static-dissipative mat and air ionization.
- **Wrist strap:** Wear a static-dissipative wrist strap to ground your body.
- **Clothing:** Wear ESD-protective clothing. Keep components away from your body and clothing. Even if you are wearing a wrist strap, your body is grounded but your clothes are not.

Cable connections

Provide sufficient strain relief for all cable connections to avoid short circuits and malfunctions.

Camera power

Operating the camera beyond the specified range damages the camera. Cameras can be powered using the I/O connector at an input range of 10.8 to 26.4 VDC, using a limited power source (LPS), according to IEC 62368-1 with maximum 2 A. The camera is not intended to be connected to a DC distribution network. The maximum length for I/O cables must not exceed 30 meters.

Alternatively, cameras can be powered over Ethernet. However, power consumption and heat generation are higher than with external power, using the I/O connector.

- Make sure that PoE power sourcing equipment is at least compliant to IEEE 802.3af/at.
- Only use power supplies that meet the insulation requirement according to PELV or SELV. For details, please refer to IEC 61140.
- If using external power supplies by third-party manufacturers, observe polarity to avoid damage to the camera electronics.

Optical components

Provide the following conditions to keep dirt and droplets out of the optical system of camera and lens:

- Dust-free environment
- Low relative humidity
- No condensation.

When camera or lens are stored:

- Cover the lens mount with a protection foil or cap.
- Cover front and back lens with caps.

Sensor

Sensors are sensitive to excessive radiation: focused sunlight, UV light, lasers, and X-rays can damage the sensor. Dirt and scratches can damage the sensor as well. Mako cameras do not need additional cleaning. Cameras are cleaned before shipping. Incorrect cleaning can damage the sensor or the filter. Therefore, never clean the sensor or the filter.

Protect the camera filter and the sensor from dirt, because dirt becomes more visible the closer it gets to the sensor. In addition, keep the back lens clean. Hold the camera with the lens mount facing the ground to keep dirt out of the lens mount.

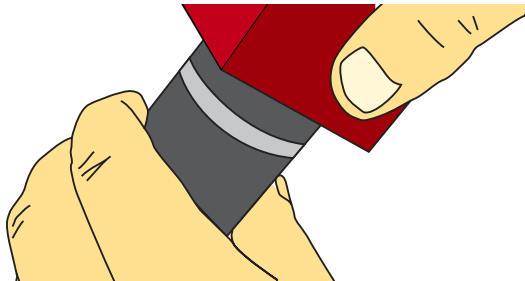

Figure 1: Holding the camera with the lens mount facing the ground

Lenses

Maximum protrusion

The sensor, filter, lens, or camera electronics can be damaged if a lens exceeding maximum protrusion is mounted to the camera. Use lenses with a maximum protrusion within camera specifications.

Specifications



This chapter includes:

Applied standards	43
Shock and vibration.....	43
Notes on specifications	44
Specifications common to all models	47
Hardware options	47
Specification tables, quantum efficiency plots, and ROI frame rates for each model, starting with Mako G-032.....	48
Camera feature availability	106
Mechanical dimensions	108
Sensor position accuracy	110
Lens protrusion for different mounts	111

Applied standards

GigE Vision

The GigE Vision standard is an interface standard for digital machine vision cameras administered by the AIA that is widely supported in the machine vision industry. In contrast, Gigabit Ethernet is the network GigE Vision is built upon.

GenICam

GenICam is a machine vision standard hosted by the EMVA. The aim of GenICam is to provide a generic configuration interface for cameras and devices independent of the used interface technology (for example, GigE Vision, USB3 Vision, DCAM IEEE 1394, Camera Link). This approach enables proper interoperability between GenICam compliant hardware and software solutions without the need for customization.

The GenICam standard consists of multiple modules that specify tasks to be solved. Allied Vision cameras and software make use of these modules, like the SFNC that standardizes feature names and types via an XML file or the transport layer interface (GenTL) that is used to grab images.

IP class

Equipped with a lens as intended, Mako cameras comply with IP30 class according to IEC 60529.

Shock and vibration

Mako cameras were successfully tested according to the following standards:

- DIN ISO 9022-3-37-01-1, Random vibration testing
- DIN ISO 9022-3-30-03-1, Shock testing
- DIN ISO 9022-3-31-01-1, Bump testing

Notes on specifications

Dimensions and mass

The dimensions listed in the following tables are for Mako standard housing models. Dimensions include the default lens mount and connectors but not the tripod and lens.

The mass listed in the following table are for Mako models only and does not include the tripod and lens.

Frame memory

Normally, an image is captured and transported in consecutive steps. The image is taken, read out from the sensor, digitized and sent over the GigE network. Mako cameras are equipped with an image buffer. Specifications tables for each camera show how many frames can be stored by each model.

The memory operates according to the FIFO principle. This makes addressing for individual images unnecessary.

Number of frames

The number of frames (`StreamHoldCapacity`) depends on resolution, pixel format, and packet size. Stated number of frames is typical for full resolution, *Mono8* or *BayerRG8*, and `GevSCPSPacketSize = 8192`.

Resolution and ROI frame rate

ROI frame rate is listed after the specification table. The resulting frame rate from changing sensor height from full image to a single line. Unless otherwise noted, sensors do not give an increase in readout speed with a reduction in width.

Unless otherwise stated, frame rate, exposure time control, trigger latency, and trigger jitter values are for 8-bit and 12-bit pixel formats only; that is, *Mono8*, *Bayer8*, *Mono12Packed*, *Bayer12Packed*, and *YUV411Packed*.

Resolution and ROI measurements

- Data was generated using `StreamBytesPerSecond = 124` Mbps (full bandwidth) and an 8-bit pixel format. Frame rates may be lower if using network hardware incapable of 124 Mbps.

- ROIs are taken as center image for maximum speed advantage, where feature $\text{OffsetY} = (\text{full sensor height} - \text{ROI height})/2$.
- **BinningVertical** is horizontal row summing on sensor before readout. The frame rate for an ROI at the same effective height as binning is slower because the sensor still needs to read out the “fast readout rows” in ROI mode.

Frame rate and readout

Although the sensor is capable of higher frame rates, readout is limited by GigE bandwidth and exposure value. You can improve frame rates with a reduced ROI and shorter exposure values.

Absolute QE plots

Before reading the QE plots

- All measurements were done without optical filters. With optical filters, QE decreases by approximately 10 percent.
- QE measurements for the Mako G-508B POL (IMX250MRZ) were measured with unpolarized light.
- The uncertainty in measurement of the QE values is ± 10 percent. This is mainly due to uncertainties in the measuring apparatus itself (Ulbricht sphere, optometer).
- Manufacturing tolerance of the sensor increases overall uncertainty.

Sony CCD and CMOS sensors

Sony provides relative response curves in their sensor data sheets. To create the absolute QE plots shown in this chapter, the relative response was converted to a normalized QE response and then adjusted as per three measured QE values (at 448 nm, 529 nm, 632 nm) for color sensors and one measured QE value (at 529 nm) for monochrome sensors.

ON Semi, CMOSIS/ams, and Teledyne e2v CMOS sensors

The curve in the absolute QE plots shown in this chapter is taken from the sensor manufacturer data sheet.

The information was correct at the time of publishing.

Wavelength

The wavelength range in the absolute QE plots reflects the information available in the sensor manufacturer data sheet at the time of publishing. Many color sensors are documented by the sensor manufacturer only for wavelengths from 400 nm to 700 nm.

Spectral response plots

The curves in the spectral response plots shown in this chapter were calculated from measured quantum efficiencies at 448 nm, 529 nm, and 632 nm. The shape of the curve is taken from the sensor data sheet but the values have been adjusted based on these measured values.

The uncertainty in measurement of the spectral response values is ± 10 percent.

Specifications common to all models

The following table provides specifications common to all Mako models.

Feature	Specification
Default lens mount	C-Mount
Default optical filter	<ul style="list-style-type: none"> • Monochrome and NIR models: No filter¹ • Color models: Type Hoya C-5000 IR cut filter
Opto-isolated I/O	1 input, 3 outputs
Operating temperature	+5 °C to +45 °C housing temperature
Storage temperature	-10°C to +70 °C ambient temperature (without condensation)
Operating humidity	20 to 80% non-condensing
Power requirements	10.8 to 26.4 VDC AUX or IEEE 802.3af (PoE)
Camera dimensions (L x W x H)	60.5 x 29.2 x 29.2 mm
Mass (typical)	80 g
Interface standard	<ul style="list-style-type: none"> • IEEE 802.3 1000BASE-T (Gigabit Ethernet) • GigE Vision Standard V1.2
Camera control standard	GenICam SFNC V1.2.1
Temperature monitoring	Available for main board only. Resolution: 0.031; Accuracy: ±1 °C

¹ As monochrome and NIR models do not have an optical filter, always attach a dust cap when a lens is not attached to minimize the possibility of contaminants falling on the sensor surface.

Table 6: Specifications common to all Mako models

Hardware options

The Modular Concept informs about options for lens mounts, optical filters, and protection glass (ASG).



Modular Concept

See the Modular Concept for hardware options, including information on ordering at www.alliedvision.com/en/support/technical-documentation/mako-documentation.

Mako G-032

The following tables provide model specifications. The values are valid for the corresponding Mako G-032B and G-032C models. For specifications common to all models, see [Specifications common to all models](#).

Feature	Specification	
	Mako G-032B	Mako G-032C
Sensor model	Sony ICX424AL	Sony ICX424AQ
Resolution (H × V)	658 × 492; 0.3 MP	
Sensor type	Interline CCD, Progressive Scan	
Shutter type	Global shutter	
Sensor format	Type 1/3	
Sensor size	6.0 mm diagonal	
Pixel size	7.4 μm × 7.4 μm	
Maximum frame rate at full resolution	102.3 fps	
Maximum image bit depth	12-bit	
Image buffer	64 MB	
StreamHoldCapacity	Up to 202 frames at full resolution	
Monochrome pixel formats	Mono8, Mono12Packed, Mono12	Mono8
YUV color pixel formats	Not applicable	YUV411Packed, YUV422Packed, YUV444Packed
RGB color pixel formats	Not applicable	RGB8Packed, BGR8Packed
RAW pixel formats	Not applicable	BayerRG8, BayerRG12, BayerRG12Packed
Exposure time control	10 μs to 93 s; 1 μs increments	
Gain control	0 to 30 dB; 1 dB increments	
Binning	Horizontal: 1 to 8 columns Vertical: 1 to 14 rows	
Power consumption	2.4 W at 12 VDC; 2.8 W PoE	
Trigger latency ¹	Idle state: 7.2 μs; Frame valid state: 16.9 μs	
Trigger jitter ¹	Idle state: ±4.0 μs; Frame valid state: ±13.7 μs	
Time between exposures	Pixel format	Value
	Mono8, Mono12Packed, BayerRG8, BayerRG12Packed, YUV411Packed	74 μs

¹ It is possible to start the exposure of the next frame while the previous frame is read out:

- Idle state: sensor is ready and camera is idle, waiting for the next trigger.
- Frame valid state: sensor is reading out and camera is busy. If next frame is requested by an external trigger in this state, higher latency may occur as compared to the Idle state.

Table 7: Mako G-032 model specifications

Absolute QE

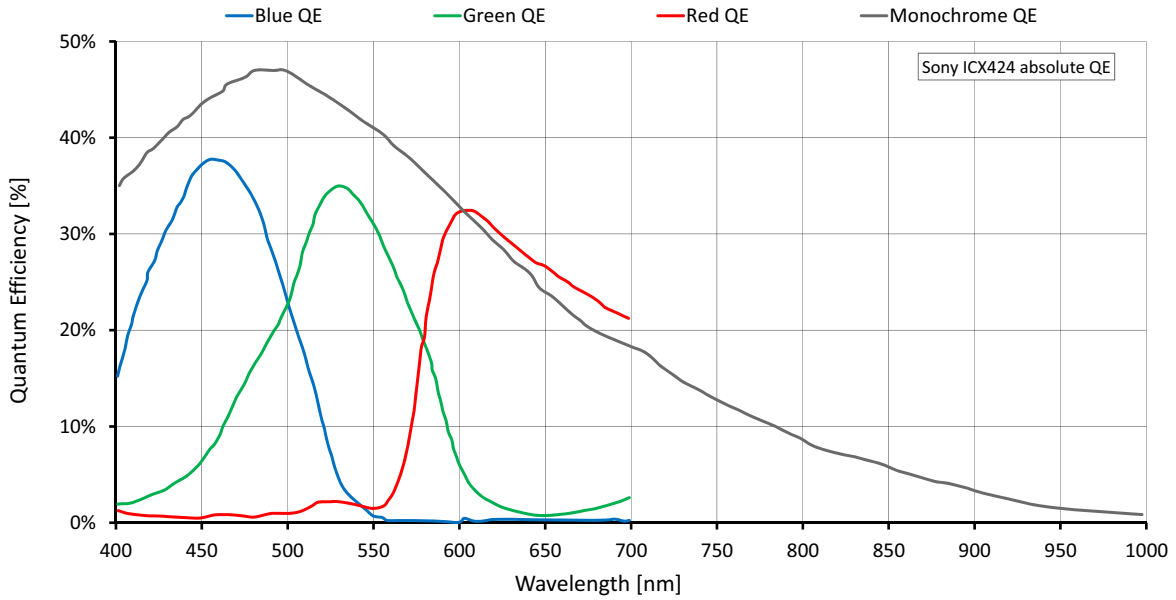

Figure 2: Mako G-032 (Sony ICX424) absolute QE

Spectral response

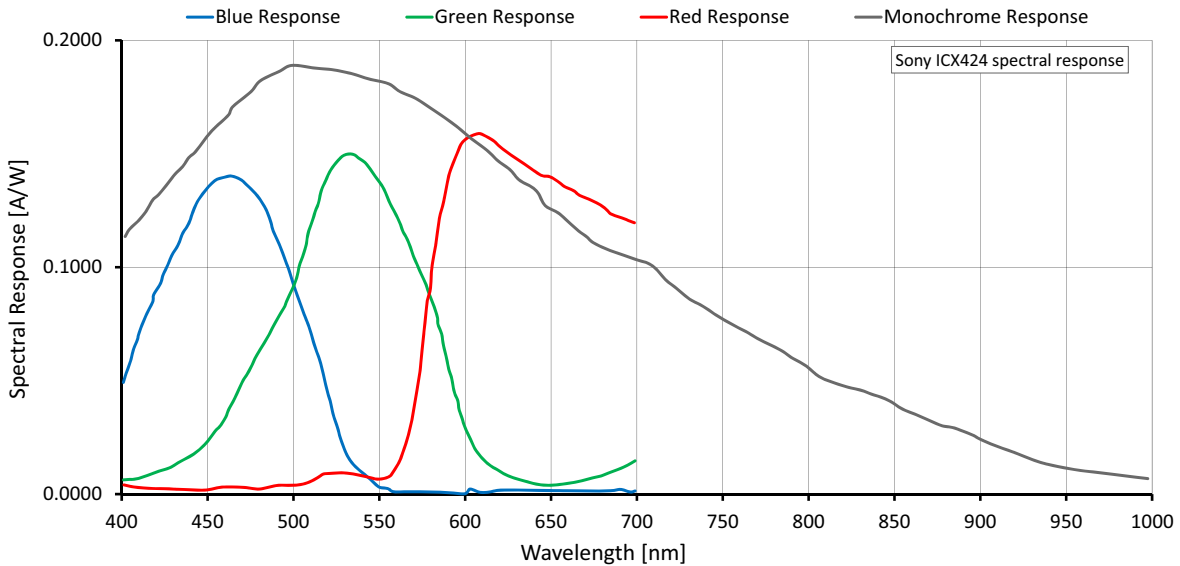

Figure 3: Mako G-032 (Sony ICX424) spectral response

ROI frame rate

$$\text{Max. frame rate} = \frac{1}{19.46 \mu\text{s} \times \text{ROI height} + 2.29 \mu\text{s} \times (492 - \text{ROI height}) + 195.81 \mu\text{s}}$$

Maximum frame rate at full resolution according to formula: 102.3 fps

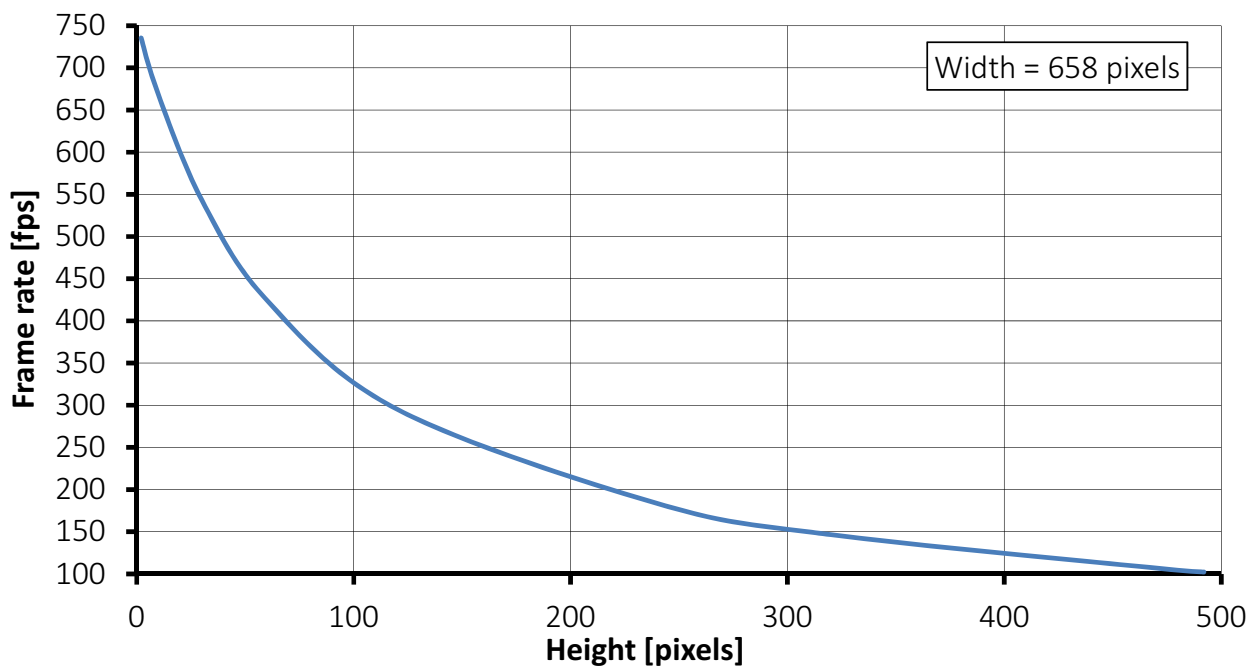

Figure 4: Mako G-032 frame rate as a function of ROI height

Height	Frame rate (fps)	Height	Frame rate (fps)
492	102.3	60	424.5
480	104.5	30	543.3
320	146.6	10	667.9
240	183.5	2	735.4
120	295.3		

Table 8: Frame rate as a function of ROI height (Width=658 pixels)



Frame rate = theoretical maximum frame rate (in fps) of the CCD sensor according to given formula.

Mako G-040

The following table provides model specifications. The values are valid for Mako G-040B and G-040C models. For specifications common to all models, see [Specifications common to all models](#).

Feature	Specification	
	Mako G-040B	Mako G-040C
Sensor model	Sony IMX287LLR Exmor	Sony IMX287LQR Exmor
Resolution (H × V)	728 × 544; 0.4 MP	
Sensor type	CMOS	
Shutter type	Pregius global shutter	
Sensor format	Type 1/2.9	
Sensor size	6.3 mm diagonal	
Pixel size	6.9 μm × 6.9 μm	
Chief ray angle ¹	0 deg	
Maximum frame rate at full resolution	286 fps (295.7 fps burst mode)	
Maximum image bit depth	12-bit	
Image buffer	64 MB	
StreamHoldCapacity	Up to 165 frames at full resolution	
Monochrome pixel formats	Mono8, Mono12Packed, Mono12	Mono8
YUV color pixel formats	Not applicable	YUV411Packed, YUV422Packed, YUV444Packed
RGB color pixel formats	Not applicable	RGB8Packed, BGR8Packed
RAW pixel formats	Not applicable	BayerRG8, BayerRG12, BayerRG12Packed
Exposure time control ²	16 μs to 85.89 s; 1 μs increments	
Gain control	0 to 40 dB; 0.1 dB increments	
Binning	Horizontal: 1 to 4 pixels; Vertical: 1 to 4 rows	
Decimation	Horizontal and Vertical: 1, 2, 4, 8 factor	
Power consumption	2.43 W at 12 VDC; 2.69 W PoE	
¹ For more information on chief ray angle, contact Allied Vision support.		
² Whenever pixel format is changed, exposure adjusts itself to the nearest multiple of the exposure increment.		

Table 9: Mako G-040 model specifications (sheet 1 of 2)

Feature	Specification	
	Mako G-040B	Mako G-040C
Trigger latency ³	Pixel format	Value
	Mono8, Mono12Packed, BayerRG8 BayerRG12Packed, YUV411Packed	17.28 μ s
	Mono12, BayerRG12, YUV422Packed	23.04 μ s
	RGB8Packed, BGR8Packed, YUV444Packed	34.56 μ s
Trigger jitter ³	Pixel format	Value
	Mono8, Mono12Packed, BayerRG8 BayerRG12Packed, YUV411Packed	\pm 2.88 μ s
	Mono12, BayerRG12, YUV422Packed	\pm 3.84 μ s
	RGB8Packed, BGR8Packed, YUV444Packed	\pm 5.76 μ s
Time between exposures	Pixel format	Value
	Mono8, Mono12Packed, BayerRG8 BayerRG12Packed, YUV411Packed	101 μ s
	Mono12, BayerRG12, YUV422Packed	140 μ s
	RGB8Packed, BGR8Packed, YUV444Packed	217 μ s

³ These values are calculated directly from the microcontroller source. There is no differentiation between Idle and Frame valid states for this sensor.

Table 9: Mako G-040 model specifications (sheet 2 of 2)

Absolute QE

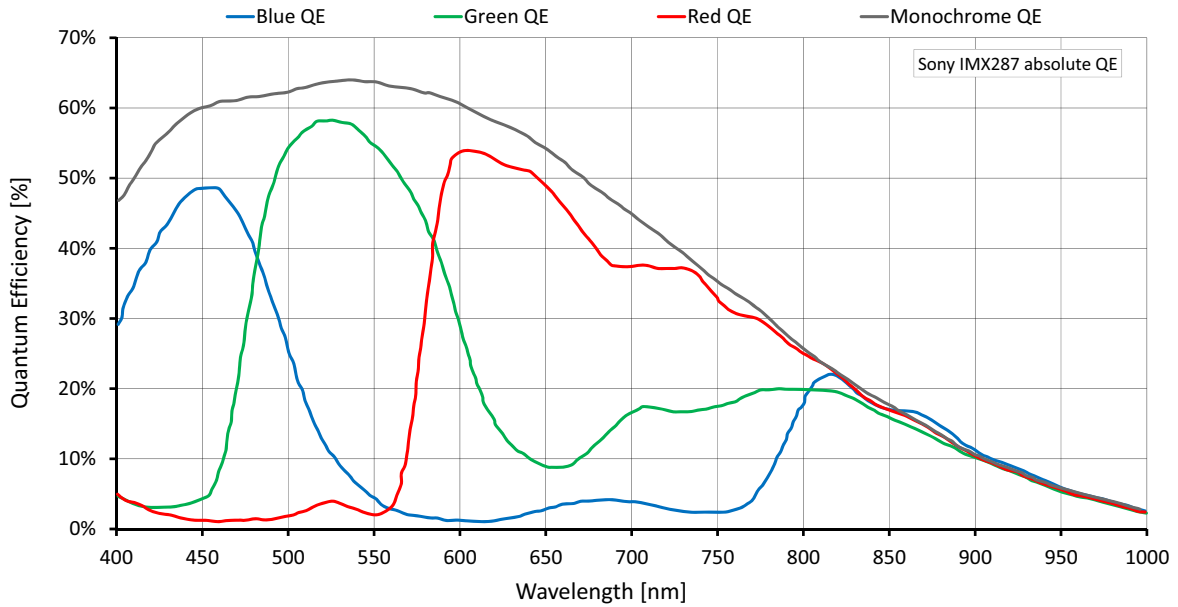

Figure 5: Mako G-040 (Sony IMX287) absolute QE

Spectral response

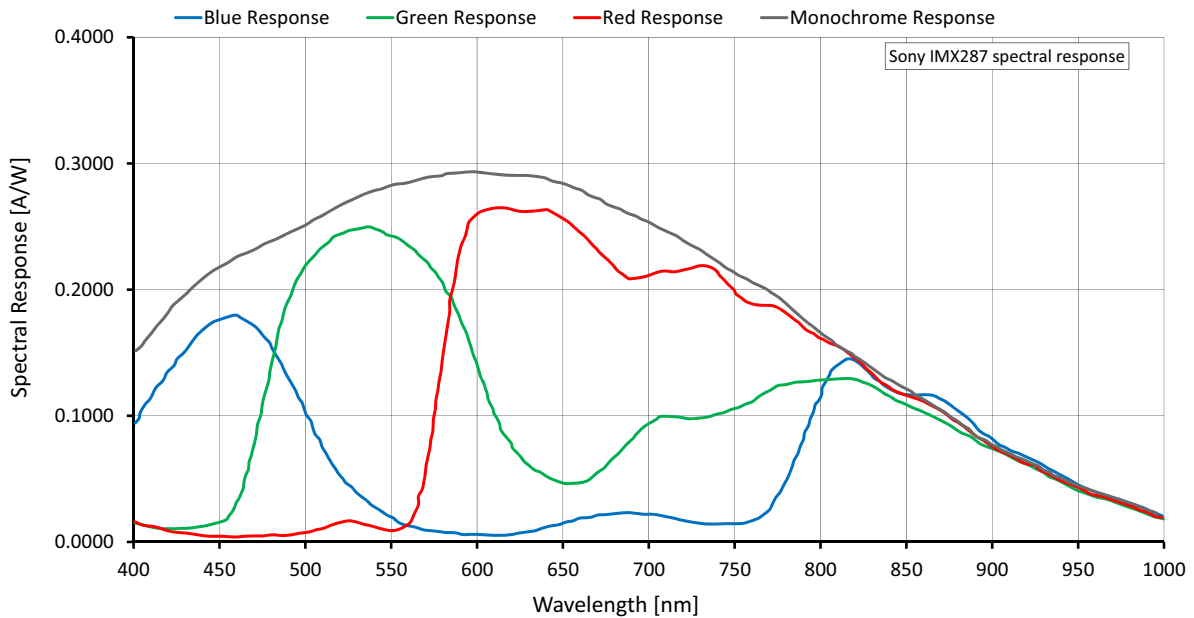

Figure 6: Mako G-040 (Sony IMX287) spectral response

ROI frame rate

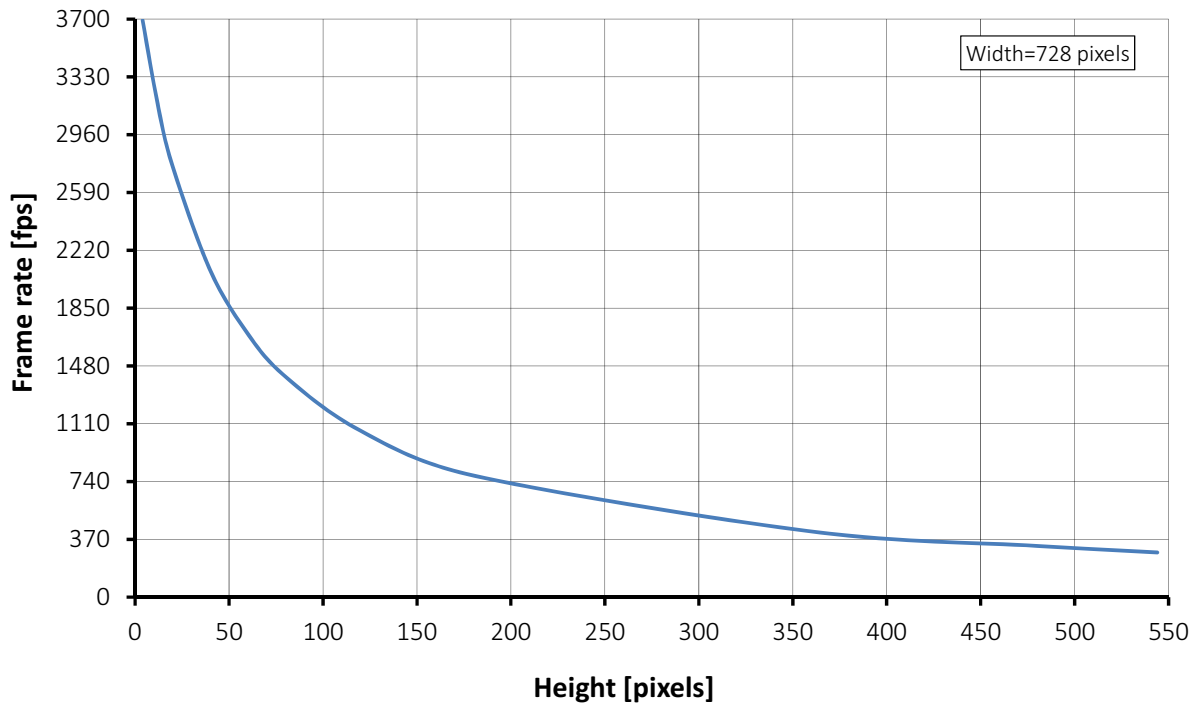

Figure 7: Mako G-040 frame rate as a function of ROI height

Height	Frame rate (fps)	Height	Frame rate (fps)
544	286.0	60	1685.5
480	328.2	40	2091.6
360	420.4	20	2755.6
180	778.5	12	3156.5
120	1065.0	4	3692.7
80	1411.4		

Table 10: Frame rate as a function of ROI height (Width=728 pixels)



There is an increase in frame rate with reduced width if the camera is bandwidth limited. Reducing the exposure time may result in higher frame rates.

Mako G-125

The following table provides model specifications. The values are valid for Mako G-125B and G-125C models. For specifications common to all models, see [Specifications common to all models](#).

Feature	Specification	
	Mako G-125B	Mako G-125C
Sensor model	Sony ICX445ALA	Sony ICX445AQA
Resolution (H × V)	1292 × 964; 1.2 MP	
Sensor type	Interline CCD, Progressive Scan	
Shutter type	Global shutter	
Sensor format	Type 1/3	
Sensor size	6.0 mm diagonal	
Pixel size	3.75 μm × 3.75 μm	
Maximum frame rate at full resolution	30.3 fps	
Maximum image bit depth	12-bit	
Image buffer	64 MB	
StreamHoldCapacity	Up to 52 frames at full resolution	
Monochrome pixel formats	Mono8, Mono12Packed, Mono12	Mono8
YUV color pixel formats	Not applicable	YUV411Packed, YUV422Packed, YUV444Packed
RGB color pixel formats	Not applicable	RGB8Packed, BGR8Packed
RAW pixel formats	Not applicable	BayerRG8, BayerRG12, BayerRG12Packed
Exposure time control	12 μs to 84 s; 1 μs increments	
Gain control	0 to 30 dB; 1 dB increments	
Binning	Horizontal: 1 to 8 columns Vertical: 1 to 14 rows	
Power consumption	2.3 W at 12 VDC; 2.7 W PoE	
Trigger latency ¹	Idle state: 8.0 μs; Frame valid state: 25.0 μs	
Trigger jitter ¹	Idle state: ±4.0 μs; Frame valid state: ±21.0 μs	
Time between exposures	Pixel format	Value
	Mono8, Mono12Packed, BayerRG8, BayerRG12Packed, YUV411Packed	70 μs

¹ It is possible to start the exposure of the next frame while the previous frame is read out:

- Idle state: sensor is ready and camera is idle, waiting for the next trigger.
- Frame valid state: sensor is reading out and camera is busy. If next frame is requested by an external trigger in this state, higher latency may occur as compared to the Idle state.

Table 11: Mako G-125 model specifications

Absolute QE

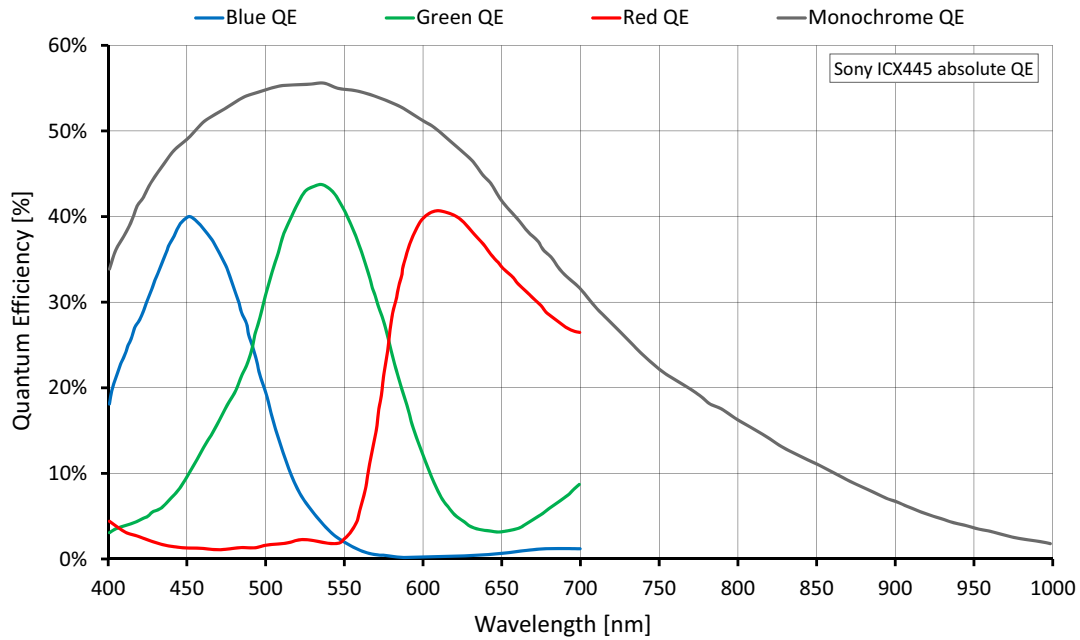

Figure 8: Mako G-125 (Sony ICX445) absolute QE

Spectral response

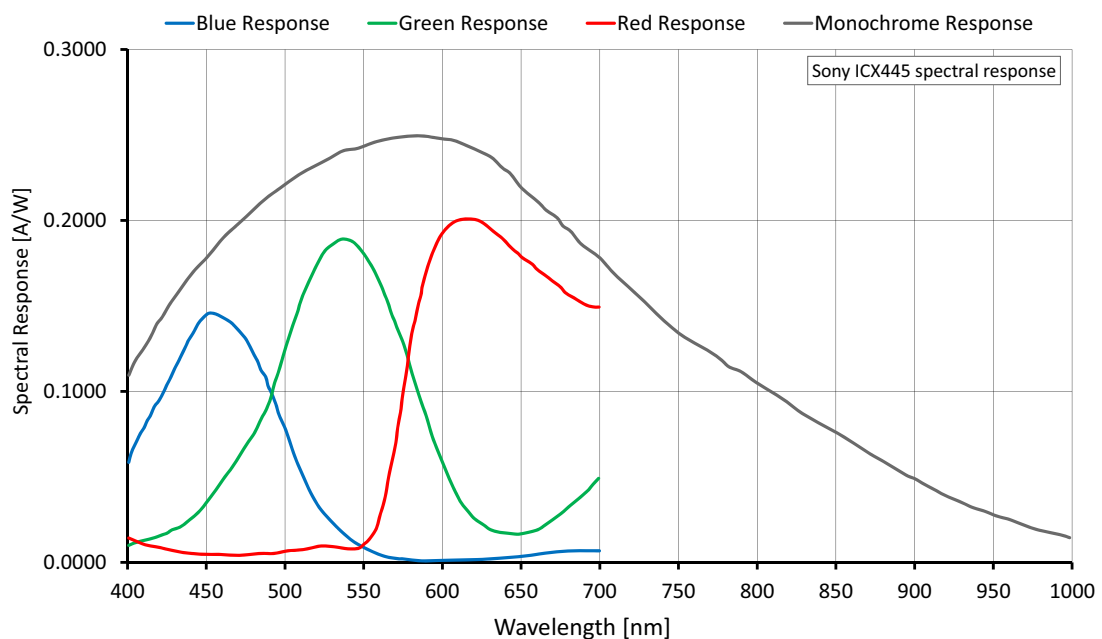

Figure 9: Mako G-125 (Sony ICX445) spectral response

ROI frame rate

$$\text{Max. frame rate} = \frac{1}{34.01 \mu\text{s} \times \text{ROI height} + 3.09 \mu\text{s} \times (964 - \text{ROI height}) + 176.42 \mu\text{s}}$$

Maximum frame rate at full resolution according to formula: 30.3 fps

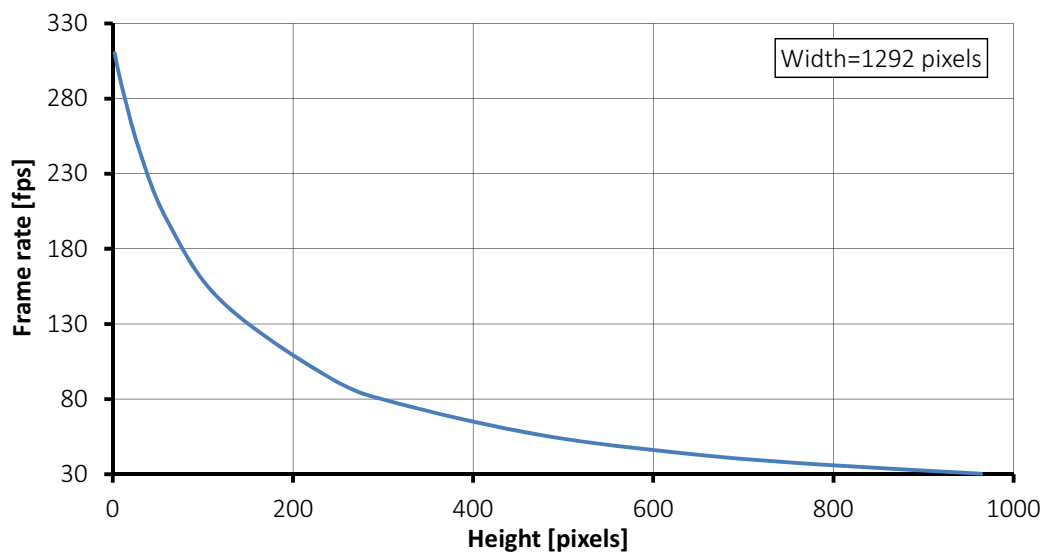

Figure 10: Mako G-125 frame rate as a function of ROI height

Height	Frame rate (fps)	Height	Frame rate (fps)
964	30.3	240	94.4
960	30.4	120	145.5
768	37.1	60	199.3
640	43.5	30	244.5
480	55.5	10	288.1
320	76.5	2	310.3

Table 12: Frame rate as a function of ROI height (Width=1292 pixels)



Frame rate = theoretical maximum frame rate (in fps) of the CCD sensor according to given formula.

Mako G-131

The following table provides model specifications. The values are valid for Mako G-131B and G-131C models. For specifications common to all models, see [Specifications common to all models](#).

Feature	Specification			
	Mako G-131B		Mako G-131C	
Sensor model	Teledyne e2v EV76C560			
Resolution (H × V)	1280 × 1024; 1.3 MP			
Sensor type	CMOS			
Shutter type	Global, Global Reset, and Rolling shutter			
Sensor format	Type 1/1.8			
Sensor size	8.7 mm diagonal			
Pixel size	5.3 μm × 5.3 μm			
Chief ray angle ¹	12 deg			
Maximum frame rate at full resolution	62 fps			
Maximum image bit depth	10-bit			
Image buffer	64 MB			
StreamHoldCapacity	Up to 50 frames at full resolution			
Monochrome pixel formats	Mono8, Mono10		Mono8	
YUV color pixel formats	Not applicable		YUV411Packed, YUV422Packed, YUV444Packed	
RGB color pixel formats	Not applicable		RGB8Packed, BGR8Packed	
RAW pixel formats	Not applicable		BayerBG8, BayerBG10	
Exposure time control ²	Pixel format	Global shutter mode	Global Reset shutter mode	Rolling shutter mode
	Mono8, Mono10, BayerBG8, BayerBG10, YUV411Packed, YUV422Packed	12 μs to 1.012 s; 1 μs increments	12 μs to 0.978 s; 1 μs increments	12 μs to 0.994 s; 1 μs increments
	RGB8Packed, BGR8Packed, YUV444Packed	12 μs to 2.124 s; 1 μs increments	12 μs to 2.053 s; 1 μs increments	12 μs to 2.086 s; 1 μs increments

¹ For more information on chief ray angle, contact Allied Vision support.

² The Teledyne e2v sensor does not support exposure duration via external level trigger.

Table 13: Mako G-131 model specifications (sheet 1 of 2)

Feature	Specification	
	Mako G-131B	Mako G-131C
Gain control	0 to 24 dB; 1 dB increments	
Binning ³	Horizontal: 1 to 2 pixels Vertical: 1 to 2 rows Teledyne e2v sensors support 1 × 1 and 2 × 2 binning	
Decimation	Horizontal and Vertical: 1, 2, 4, 8 factor	
Power consumption	2.0 W at 12 VDC; 2.2 W PoE	
Trigger latency ⁴	Idle state: 32.6 μs; Frame valid state: 32.6 μs	
Trigger jitter ⁴	Idle state: ±8.1 μs; Frame valid state: ±8.1 μs	
Time before exposures	Pixel format	Value
	Mono8, BayerBG8, YUV411Packed	24 μs

³ Mako G-131 supports **BinningHorizontalMode = Sum or Average** and **BinningVerticalMode = Sum or Average**.

⁴ These values are calculated directly from the microcontroller source. These values are only valid for pixel formats < 16 bits per pixel and applicable in both Idle and Frame valid states:

- Idle state: sensor is ready and camera is idle, waiting for the next trigger.
- Frame valid state: sensor is reading out and camera is busy. If next frame is requested by an external trigger in this state, higher latency may occur as compared to the Idle state.

Table 13: Mako G-131 model specifications (sheet 2 of 2)



Overlapping exposure and readout

The Teledyne e2v sensor does not support overlapped exposure and readout in hardware trigger mode or in global reset mode.

Absolute QE

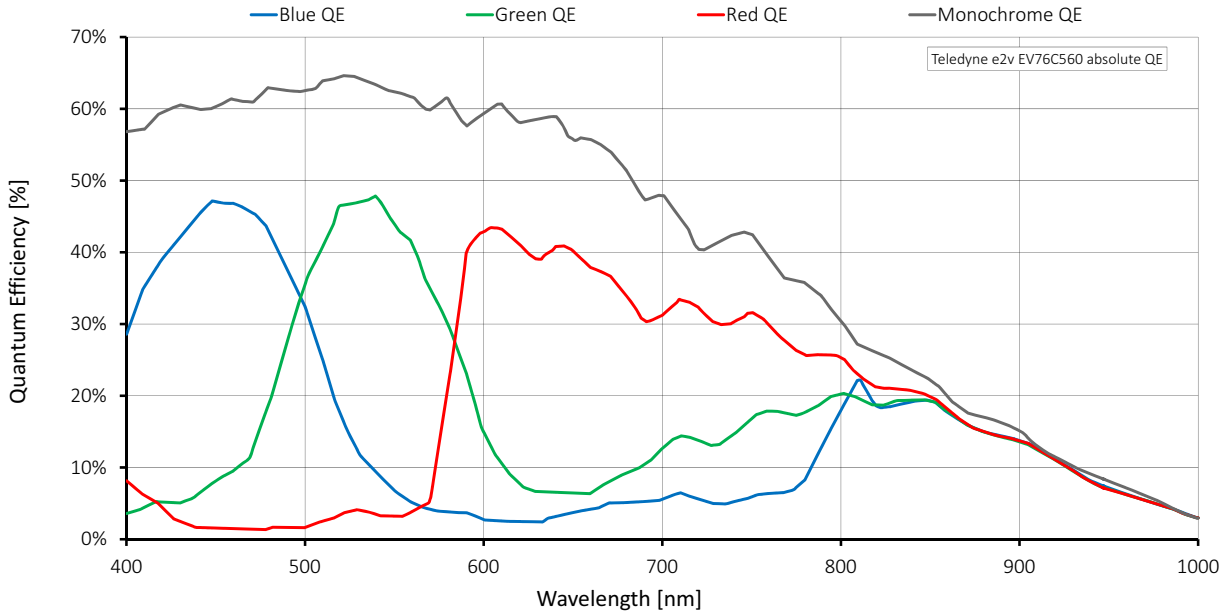

Figure 11: Mako G-131 (Teledyne e2v EV76C560) absolute QE

Spectral response

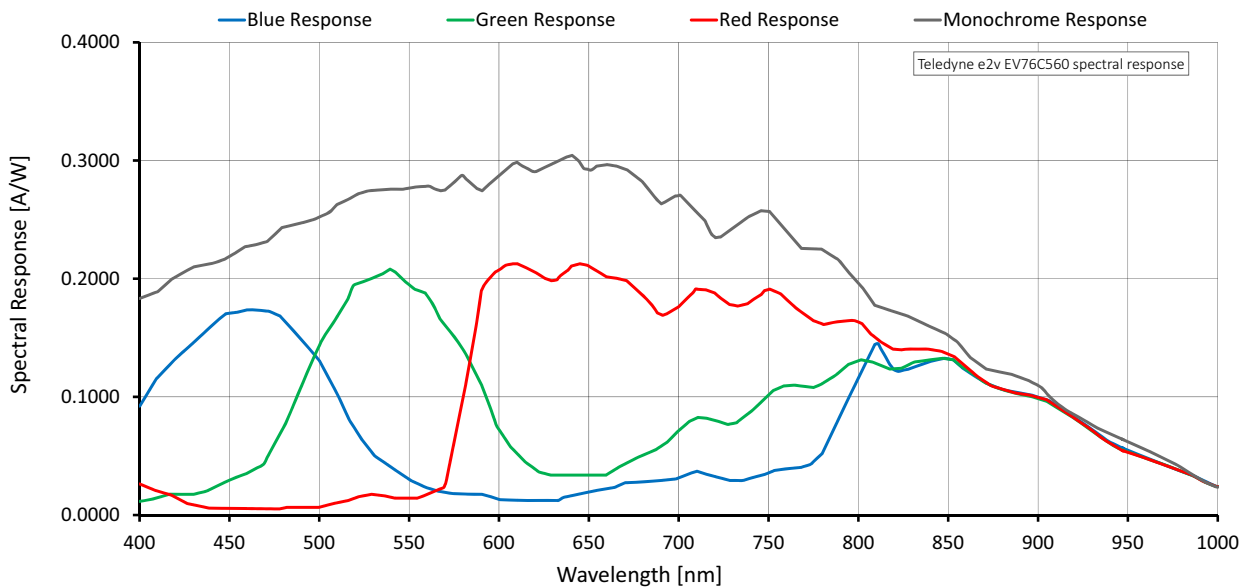

Figure 12: Mako G-131 (Teledyne e2v EV76C560) spectral response

ROI frame rate

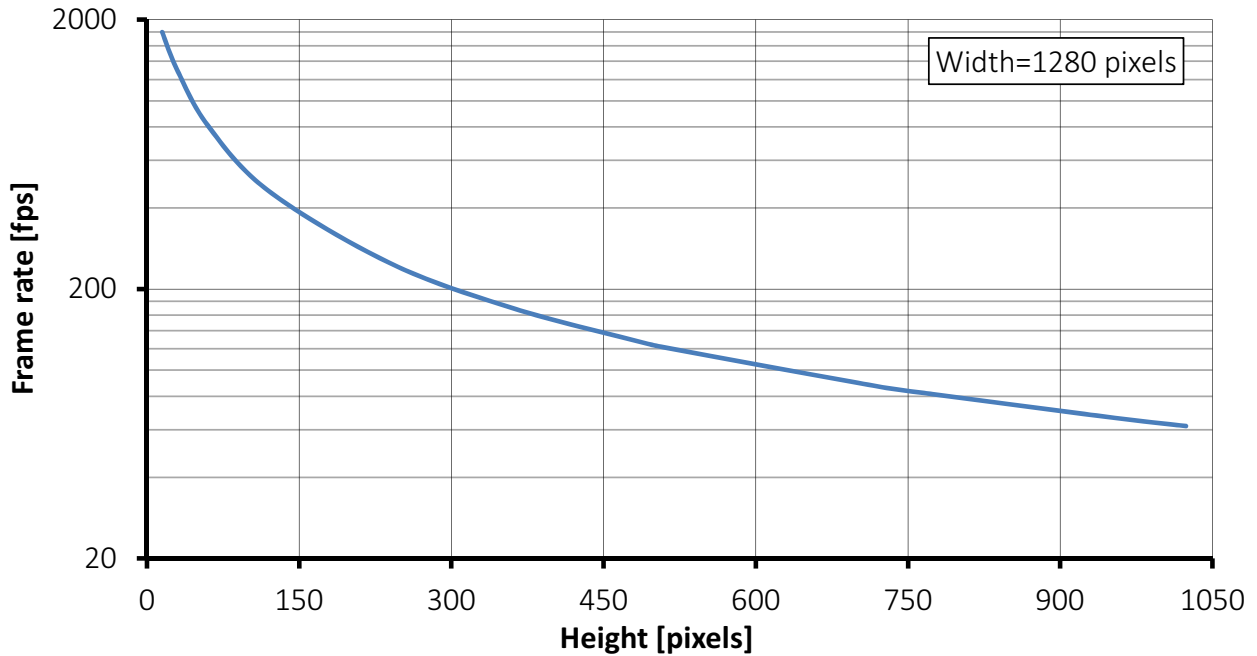

Figure 13: Mako G-131 frame rate as a function of ROI height

Height	Frame rate (fps)	Height	Frame rate (fps)
1024	62.0	360	170.0
960	66.0	240	249.0
768	82.0	120	462.0
720	87.0	60	809.0
512	121.0	30	1295.0
480	129.0	15	1798.0

Table 14: Frame rate as a function of ROI height (Width=1280 pixels)



There is an increase in frame rate with reduced width if the camera is bandwidth limited.

Mako G-158

The following table provides model specifications. The values are valid for Mako G-158B and G-158C models. For specifications common to all models, see [Specifications common to all models](#).

Feature	Specification	
	Mako G-158B	Mako G-158C
Sensor model	Sony IMX273LLR Exmor	Sony IMX273LQR Exmor
Resolution (H × V)	1456 × 1088; 1.58 MP	
Sensor type	CMOS	
Shutter type	Pregius global shutter	
Sensor format	Type 1/2.9	
Sensor size	6.3 mm diagonal	
Pixel size	3.45 μm × 3.45 μm	
Chief ray angle ¹	0 deg	
Maximum frame rate at full resolution	75.2 fps (78.9 fps burst mode)	
Maximum image bit depth	12-bit	
Image buffer	64 MB	
StreamHoldCapacity	Up to 41 frames at full resolution	
Monochrome pixel formats	Mono8, Mono12Packed, Mono12	Mono8
YUV color pixel formats	Not applicable	YUV411Packed, YUV422Packed, YUV444Packed
RGB color pixel formats	Not applicable	RGB8Packed, BGR8Packed
RAW pixel formats	Not applicable	BayerRG8, BayerRG12, BayerRG12Packed
Exposure time control ²	16 μs to 85.89 s; 1 μs increments	
Gain control	0 to 40 dB; 0.1 dB increments	
Binning	Horizontal: 1 to 4 pixels; Vertical: 1 to 4 rows	
Decimation	Horizontal and Vertical: 1, 2, 4, 8 factor	
Power consumption	2.43 W at 12 VDC; 2.68 W PoE	

¹ For more information on chief ray angle, contact Allied Vision support.

² Whenever pixel format is changed, exposure adjusts itself to the nearest multiple of the exposure increment.

Table 15: Mako G-158 model specifications (sheet 1 of 2)

Feature	Specification	
	Mako G-158B	Mako G-158C
Trigger latency ³	Pixel format	Value
	Mono8, Mono12Packed, BayerRG8 BayerRG12Packed, YUV411Packed	33.6 μ s
	Mono12, BayerRG12, YUV422Packed	44.64 μ s
	RGB8Packed, BGR8Packed, YUV444Packed	67.2 μ s
Trigger jitter ³	Pixel format	Value
	Mono8, Mono12Packed, BayerRG8 BayerRG12Packed, YUV411Packed	\pm 5.6 μ s
	Mono12, BayerRG12, YUV422Packed	\pm 7.44 μ s
	RGB8Packed, BGR8Packed, YUV444Packed	\pm 11.2 μ s
Time between exposures	Pixel format	Value
	Mono8, Mono12Packed, BayerRG8 BayerRG12Packed, YUV411Packed	210 μ s
	Mono12, BayerRG12, YUV422Packed	285 μ s
	RGB8Packed, BGR8Packed, YUV444Packed	434 μ s

³ These values are calculated directly from the microcontroller source. There is no differentiation between Idle and Frame valid states for this sensor.

Table 15: Mako G-158 model specifications (sheet 2 of 2)

Absolute QE

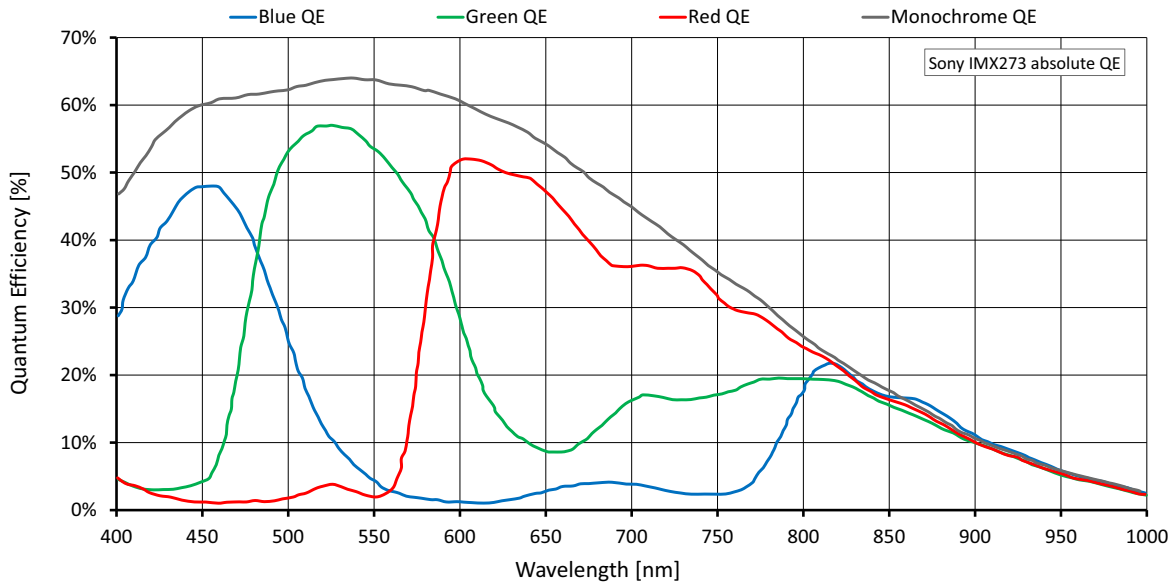

Figure 14: Mako G-158 (Sony IMX273) absolute QE

Spectral response

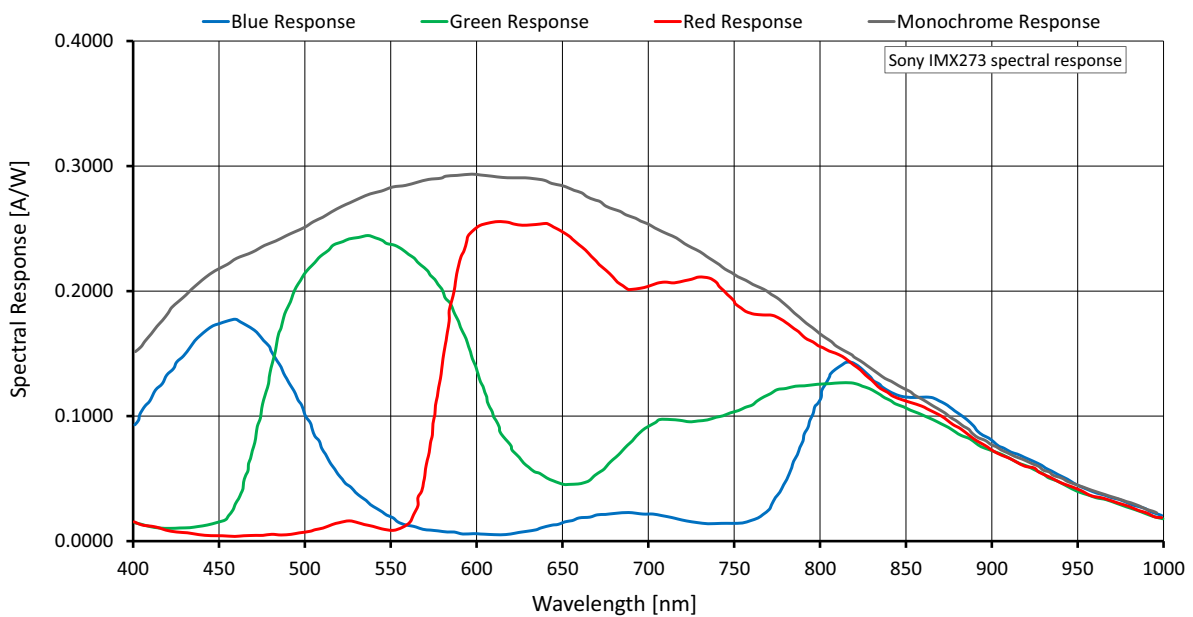

Figure 15: Mako G-158 (Sony IMX273) spectral response

ROI frame rate

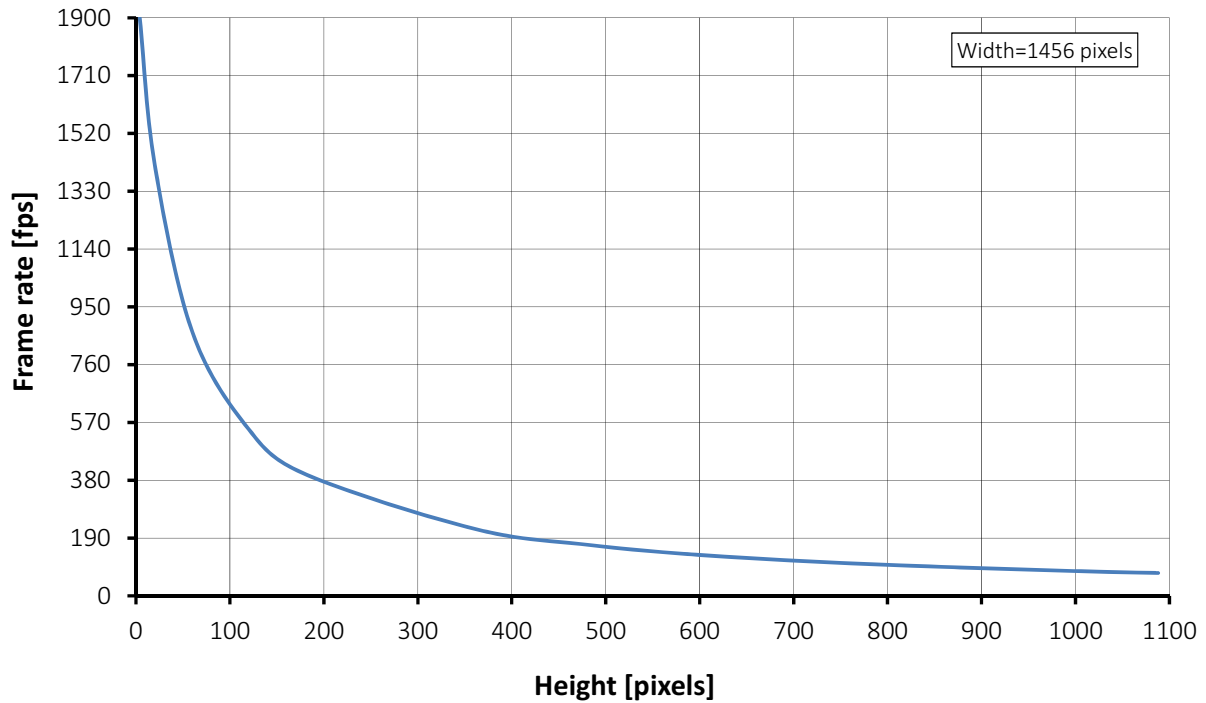

Figure 16: Mako G-158 frame rate as a function of ROI height

Height	Frame rate (fps)	Height	Frame rate (fps)
1088	75.2	360	220.5
1080	75.6	180	400.4
1024	79.6	120	547.8
960	85.2	60	866.9
768	105.9	20	1417.2
600	134.5	4	1899.7
480	168.1		

Table 16: Frame rate as a function of ROI height (Width=1456 pixels)



There is an increase in frame rate with reduced width if the camera is bandwidth limited. Reducing the exposure time may result in higher frame rates.

Mako G-192

The following table provides model specifications. The values are valid for Mako G-192B and G-192C models. For specifications common to all models, see [Specifications common to all models](#).

Feature	Specification		
	Mako G-192B	Mako G-192C	
Sensor model	Teledyne e2v EV76C570		
Resolution (H × V)	1600 × 1200; 1.9 MP		
Sensor type	CMOS		
Shutter type	Global, Global Reset, and Rolling shutter		
Sensor format	Type 1/1.8		
Sensor size	9 mm diagonal		
Pixel size	4.5 μm × 4.5 μm		
Chief Ray Angle ¹	12 deg		
Maximum frame rate at full resolution	60 fps		
Maximum image bit depth	10-bit		
Image buffer	64 MB		
StreamHoldCapacity	Up to 34 frames at full resolution		
Monochrome pixel formats	Mono8, Mono10	Mono8	
YUV color pixel formats	Not applicable	YUV411Packed, YUV422Packed, YUV444Packed	
RGB color pixel formats	Not applicable	RGB8Packed, BGR8Packed	
RAW pixel formats	Not applicable	BayerBG8, BayerBG10	
Exposure time control ²	Pixel format	Global or Rolling shutter mode	Global Reset shutter mode
	Mono8, Mono10, BayerBG8, BayerBG10, YUV411Packed, YUV422Packed	14 μs to 0.891 s; 1 μs increments	14 μs to 0.874 s; 1 μs increments
	RGB8Packed, BGR8Packed, YUV444Packed	14 μs to 1.870 s; 1 μs increments	14 μs to 1.835 s; 1 μs increments
Gain control	0 to 24 dB; 1 dB increments		

¹ For more information on chief ray angle, contact Allied Vision support.

² The Teledyne e2v sensor does not support exposure duration via external level trigger.

Table 17: Mako G-192 model specifications (sheet 1 of 2)

Feature	Specification	
	Mako G-192B	Mako G-192C
Binning ³	Horizontal: 1 to 2 pixels Vertical: 1 to 2 rows Teledyne e2v sensors support 1x1 and 2x2 binning.	
Decimation	Horizontal and Vertical: 1, 2, 4, 8 factor	
Power consumption	2.1 W at 12 VDC; 2.4 W PoE	
Trigger latency ⁴	Idle state: 27.7 μ s; Frame valid state: 27.7 μ s	
Trigger jitter ⁴	Idle state: \pm 6.9 μ s; Frame valid state: \pm 6.9 μ s	
Time between exposures	Pixel format	Value
	Mono8, BayerBG8, YUV411Packed	34 μ s
³ Mako G-192 supports BinningHorizontalMode = <i>Sum</i> or <i>Average</i> and BinningVerticalMode = <i>Sum</i> or <i>Average</i> .		
⁴ These values are calculated directly from the microcontroller source. These values are only valid for pixel formats < 16 bits per pixel and applicable in both Idle and Frame valid state: <ul style="list-style-type: none"> • Idle state: sensor is ready and camera is idle, waiting for the next trigger. • Frame valid state: sensor is reading out and camera is busy. If next frame is requested by an external trigger in this state, higher latency may occur as compared to the Idle state. 		

Table 17: Mako G-192 model specifications (sheet 2 of 2)



Overlapping exposure and readout

The Teledyne e2v sensor does not support overlapped exposure and readout in hardware trigger mode or in global reset mode.

Absolute QE

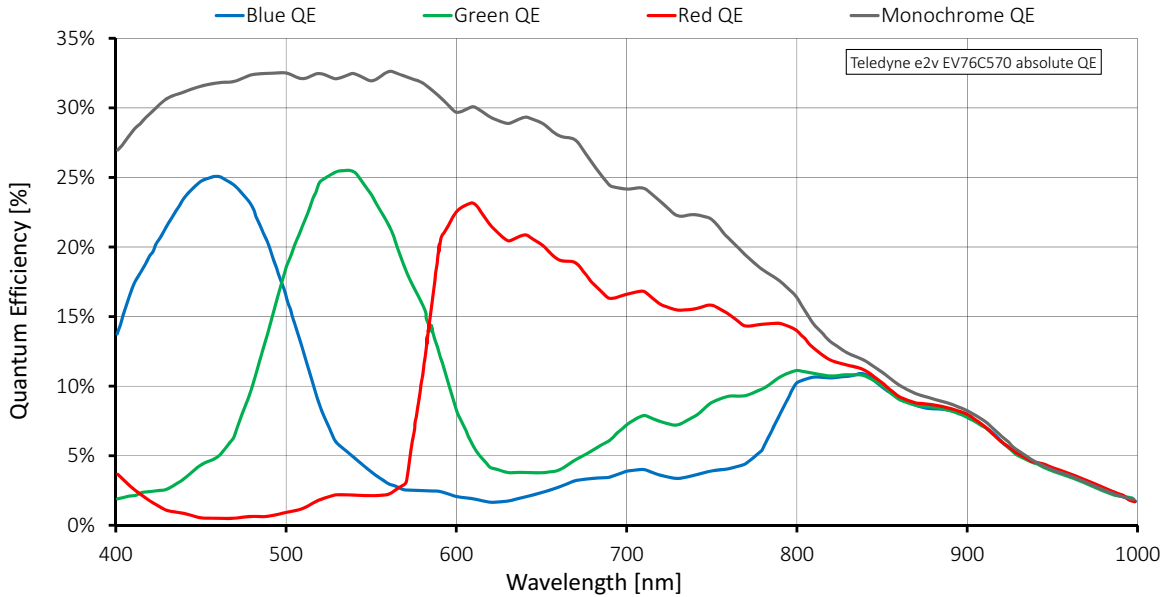

Figure 17: Mako G-192 (Teledyne e2v EV76C570) absolute QE

Spectral response

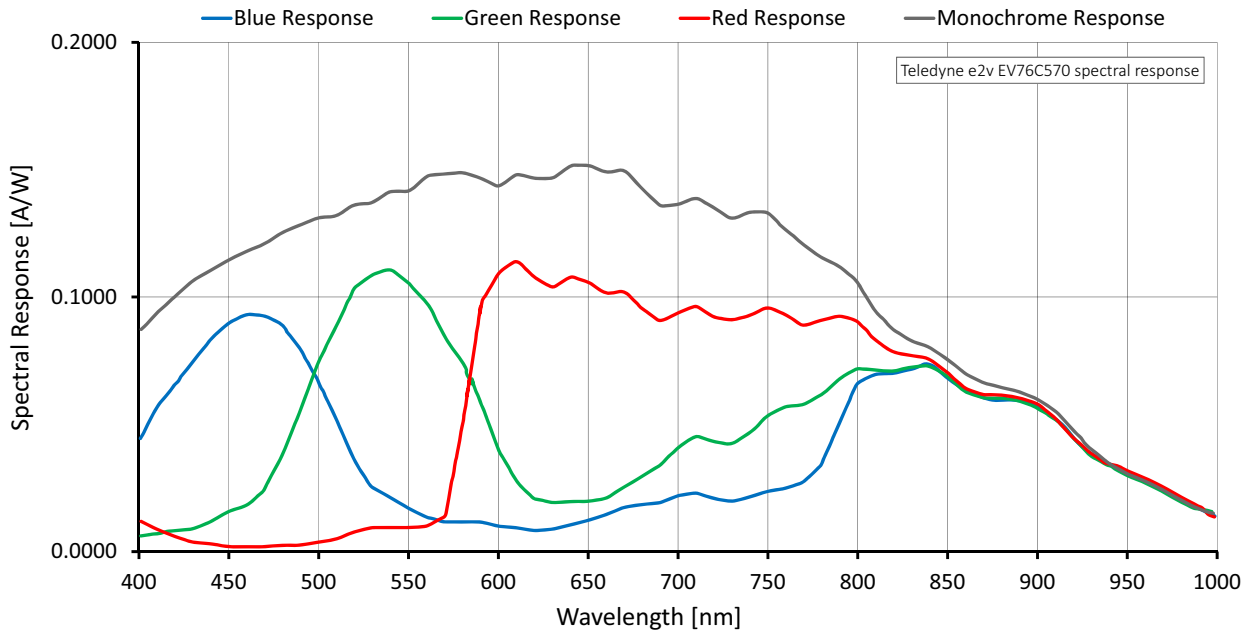

Figure 18: Mako G-192 (Teledyne e2v EV76C570) absolute QE

ROI frame rate

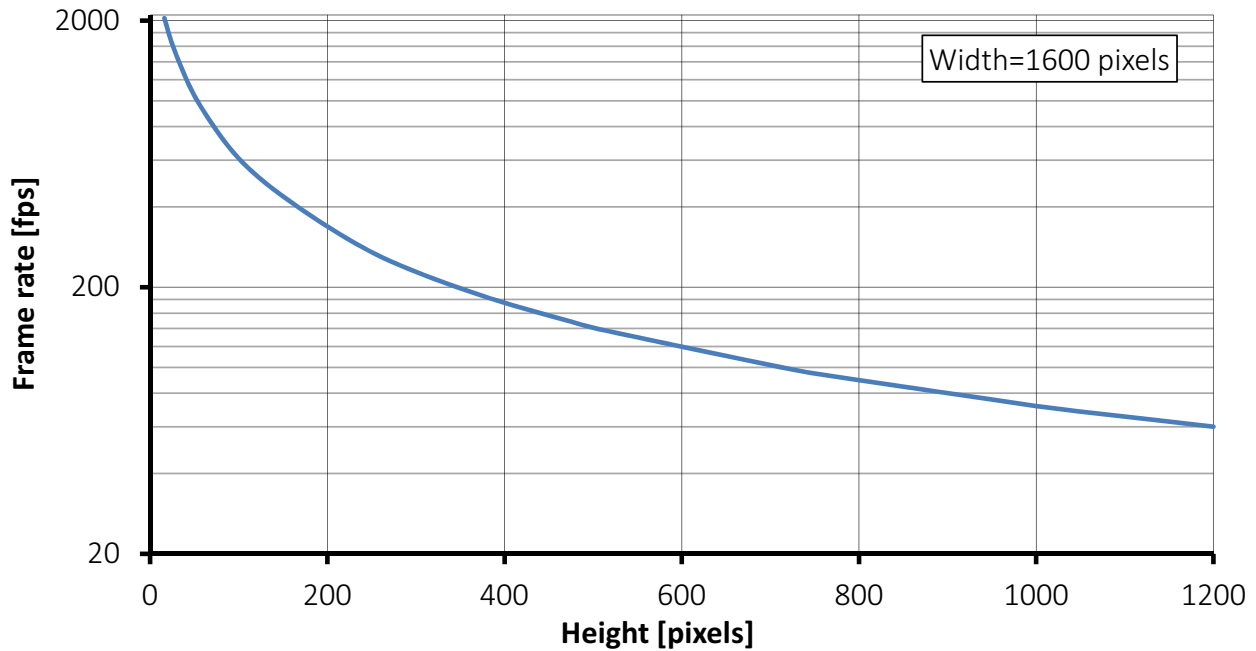

Figure 19: Mako G-192 frame rate as a function of ROI height

Height	Frame rate (fps)	Height	Frame rate (fps)
1200	60.0	360	193.0
1024	70.0	240	282.0
960	75.0	120	525.0
768	93.0	60	919.0
720	99.0	30	1470.0
512	138.0	16	2042.0
480	147.0		

Table 18: Frame rate as a function of ROI height (Width=1600 pixels)



There is an increase in frame rate with reduced width if the camera is bandwidth limited.

Mako G-223

The following table provides model specifications. The values are valid for Mako G-223B and G-223C models. For specifications common to all models, see [Specifications common to all models](#).

Feature	Specification	
	Mako G-223B	Mako G-223C
Sensor model	CMOSIS/ams CMV2000 with microlens	
Resolution (H × V)	2048 × 1088; 2.2 MP	
Sensor type	CMOS	
Shutter type	Global shutter	
Sensor format	Type 2/3	
Sensor size	12.7 mm diagonal	
Pixel size	5.5 μm × 5.5 μm	
Maximum frame rate at full resolution	49.5 fps	
Maximum image bit depth	12-bit	
Image buffer	64 MB	
StreamHoldCapacity	Up to 29 frames at full resolution	
Monochrome pixel formats	Mono8, Mono12Packed, Mono12	Mono8
YUV color pixel formats	Not applicable	YUV411Packed, YUV422Packed, YUV444Packed
RGB color pixel formats	Not applicable	RGB8Packed, BGR8Packed
RAW pixel formats	Not applicable	BayerGB8, BayerGB12, BayerGB12Packed
Exposure time control ¹	30 μs to 153 s; 1 μs increments	
Gain control	0 to 26 dB; 1 dB increments	
Power consumption	2.4 W at 12 VDC; 2.8 W PoE	
Trigger latency ²	3.205 μs	
Trigger jitter ²	±0.15 μs	
Time between exposures	Pixel format	Value
	Mono8, Mono12Packed, BayerGB8, BayerGB12Packed, YUV411Packed	84 μs

¹ Camera firmware version ≤ 01.52.8151 or later shows minimum exposure values without frame overhead time, that is, 1 μs. See the sensor data sheet for details on frame overhead time.

² Trigger latency and trigger jitter values were measured at the external I/O (8-bit pixel format).

Table 19: Mako G-223 model specifications

Absolute QE

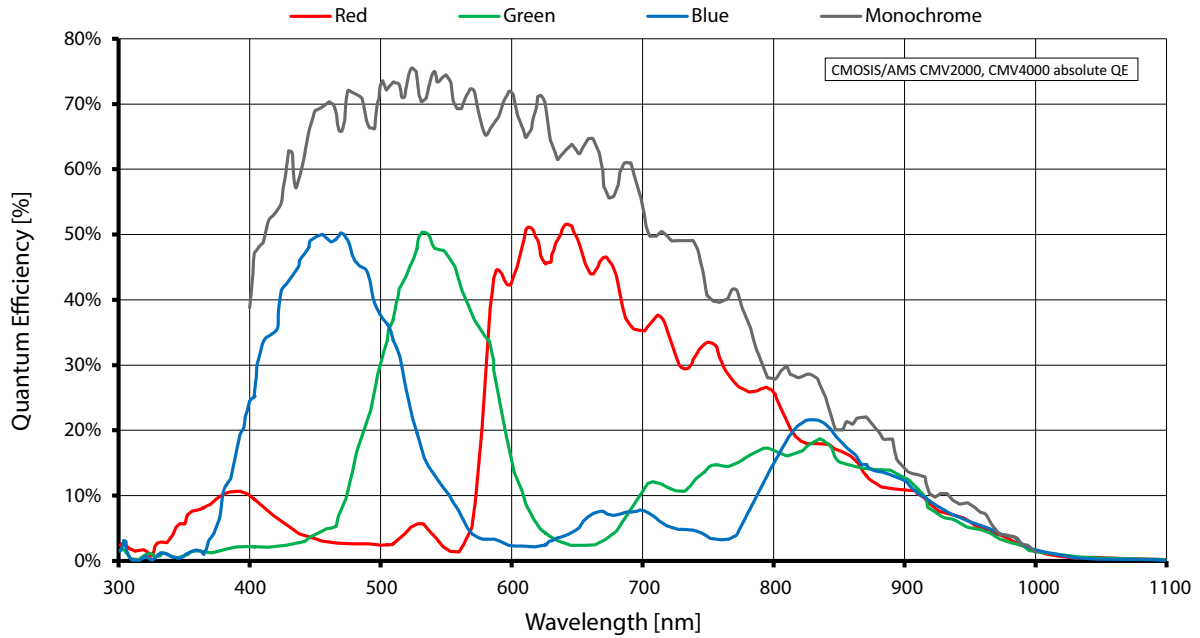

Figure 20: Mako G-223 (CMOSIS/ams CMV2000) absolute QE

Spectral response

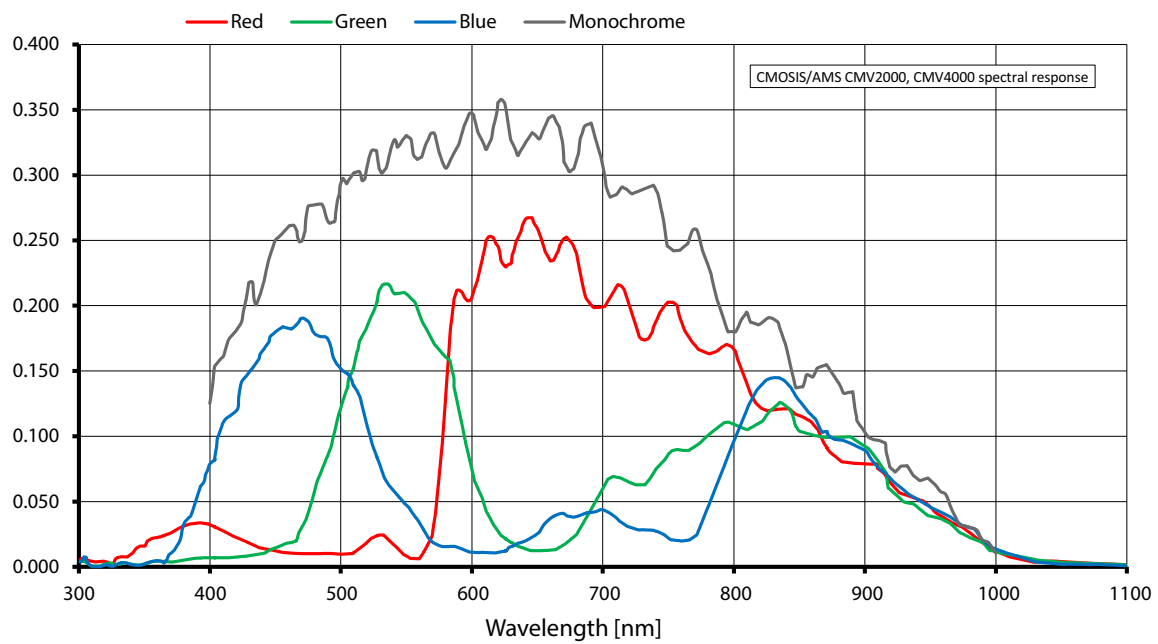

Figure 21: Mako G-223 (CMOSIS/ams CMV2000) spectral response

ROI frame rate

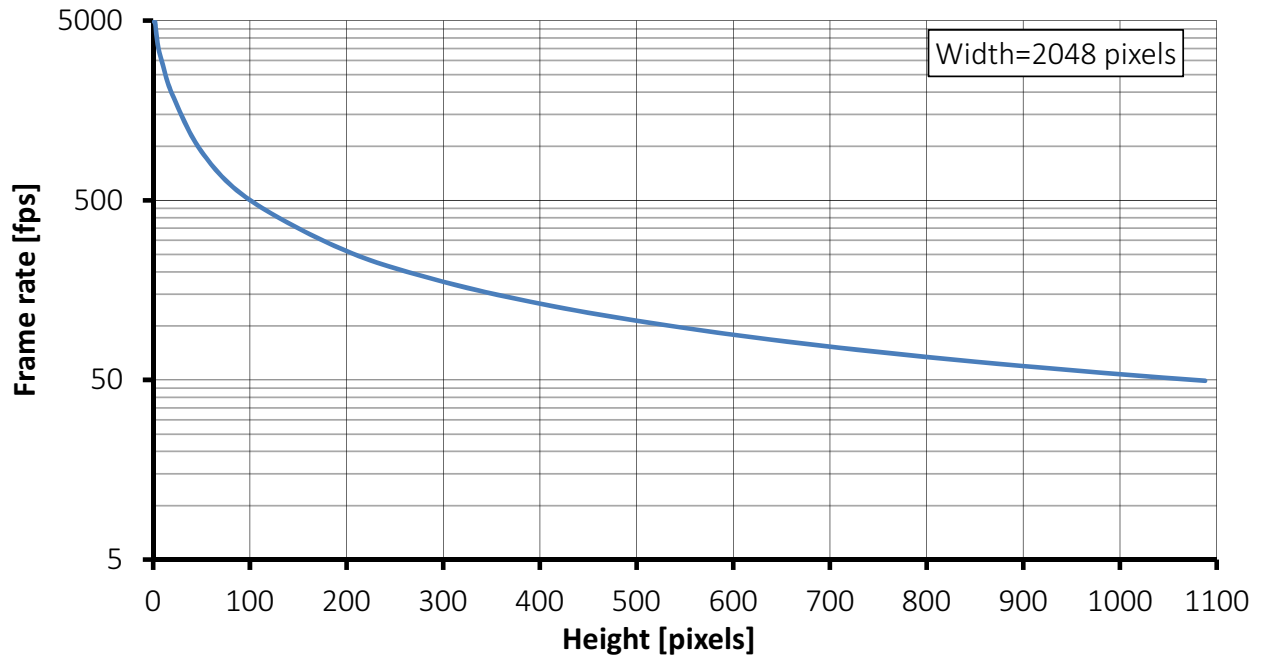

Figure 22: Mako G-223 frame rate as a function of ROI height

Height	Frame rate (fps)	Height	Frame rate (fps)
1088	49.5	200	260.8
1000	53.8	100	502.1
900	59.7	50	934.6
800	67.1	20	1933.8
700	76.6	10	2847.3
600	89.2	5	3624.5
500	106.8	2	4906.7
400	132.9	1	4926.1
300	176.1		

Table 20: Frame rate as a function of ROI height (Width=2048 pixels)



There is an increase in frame rate with reduced width if the camera is bandwidth limited.

Mako G-234

The following table provides model specifications. The values are valid for Mako G-234B and G-234C models. For specifications common to all models, see [Specifications common to all models](#).

Feature	Specification	
	Mako G-234B	Mako G-234C
Sensor model	Sony IMX249LLJ Exmor	Sony IMX249LQJ Exmor
Resolution (H × V)	1936 × 1216; 2.35 MP	
Sensor type	CMOS	
Shutter type	Pregius global shutter	
Sensor format	Type 1/1.2	
Sensor size	13.4 mm diagonal	
Pixel size	5.86 μm × 5.86 μm	
Chief Ray Angle ¹	0 deg	
Sensor output	10-bit or 12-bit	
Maximum frame rate at full resolution	41.5 fps (10-bit); 32.3 fps (12-bit)	
Maximum image bit depth	12-bit	
Image buffer	64 MB	
StreamHoldCapacity	Up to 28 frames at full resolution	
Monochrome pixel formats	Mono8, Mono12Packed, Mono12	Mono8
YUV color pixel formats	Not applicable	YUV411Packed, YUV422Packed, YUV444Packed
RGB color pixel formats	Not applicable	RGB8Packed, BGR8Packed
RAW pixel formats	Not applicable	BayerRG8, BayerRG12, BayerRG12Packed
Exposure time control ²	16 μs to 85.89 s; 1 μs increments	
Gain control	0 to 40 dB; 0.1 dB increments	
Binning	Horizontal: 1 to 4 pixels; Vertical: 1 to 4 rows	
Decimation	Horizontal and Vertical: 1, 2, 4, 8 factor	
Power consumption	2.4 W at 12 VDC; 2.8 W PoE	

¹ For more information on chief ray angle, contact Allied Vision support.

² Whenever pixel format is changed, Exposure adjusts itself to the nearest multiple of the exposure increment.

Table 21: Mako G-234 model specifications (sheet 1 of 2)

Feature	Specification	
	Mako G-234B	Mako G-234C
Trigger latency ³	Pixel format	Value
	Mono8, BayerRG8, BayerRG12, BayerRG12Packed, YUV411Packed, YUV422Packed	57.6 μ s (10-bit), 73.92 μ s (12-bit)
	RGB8Packed, BGR8Packed, YUV444Packed	115.2 μ s (10-bit), 147.84 μ s (12-bit)
Trigger jitter ³	Pixel format	Value
	Mono8, BayerRG8, BayerRG12, BayerRG12Packed, YUV411Packed, YUV422Packed	\pm 9.6 μ s (10-bit), \pm 12.32 μ s (12-bit)
	RGB8Packed, BGR8Packed, YUV444Packed	\pm 19.2 μ s (10-bit), \pm 24.64 μ s (12-bit)
Time between exposures	Pixel format	Value
	Mono8, BayerRG8, BayerRG12, BayerRG12Packed, YUV411Packed, YUV422Packed	275 μ s (10-bit), 356 μ s (12-bit)
	RGB8Packed, BGR8Packed, YUV444Packed	563 μ s (10-bit), 726 μ s (12-bit)

³ These values are calculated directly from the microcontroller source. There is no differentiation between Idle and Frame valid states for this sensor.

Table 21: Mako G-234 model specifications (sheet 2 of 2)



With 10-bit sensor readout mode you can achieve a higher frame rate. The sensor is capable of higher frame rates but readout is limited by GigE bandwidth and exposure value. You can improve frame rates with a reduced ROI and shorter exposure values.

For more information on **SensorReadoutMode**, see the GigE Features Reference.

Absolute QE

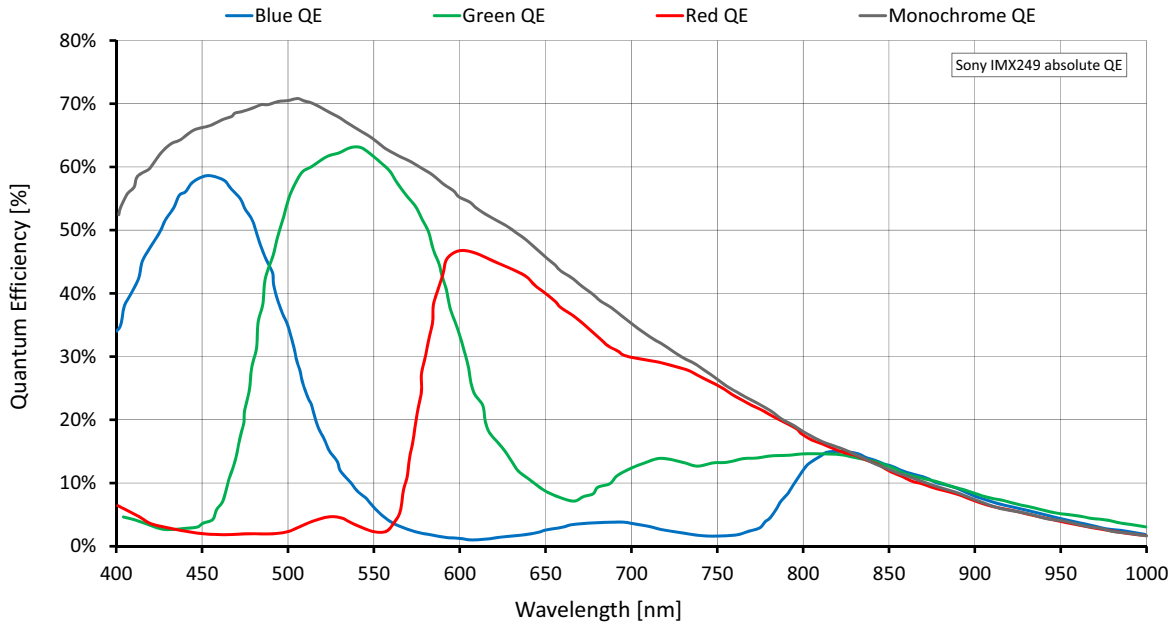

Figure 23: Mako G-234 (Sony IMX249) absolute QE

Spectral response

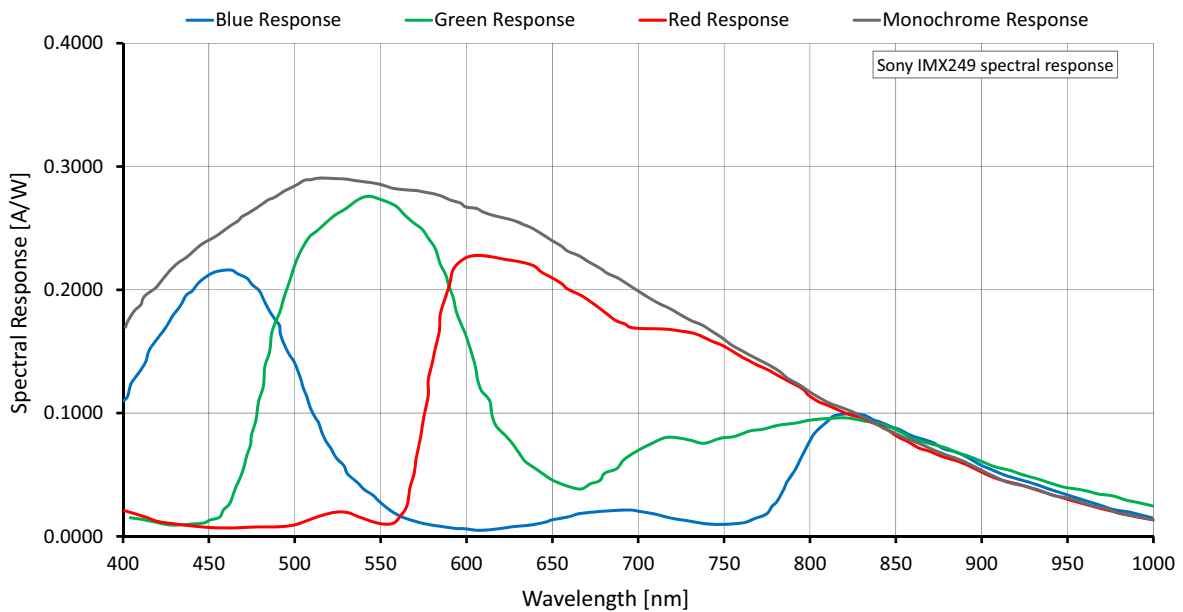

Figure 24: Mako G-234 (Sony IMX249) spectral response

ROI frame rate

12-bit sensor readout

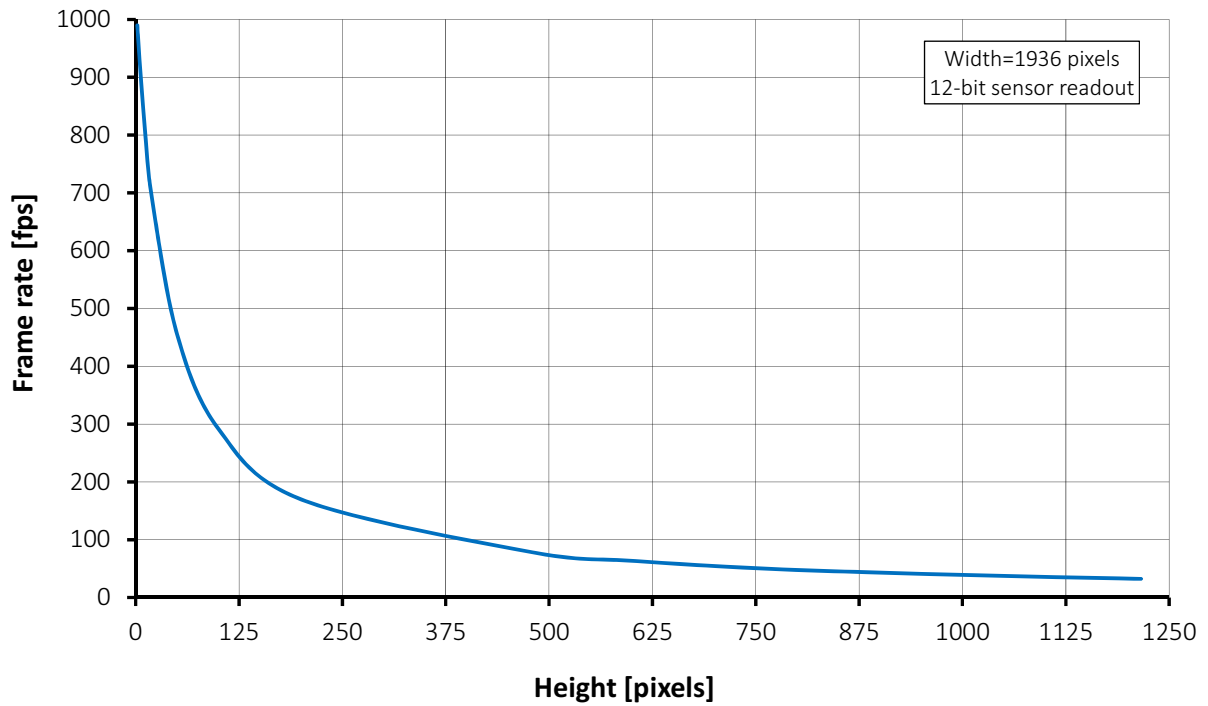

Figure 25: Mako G-234 12-bit sensor frame rate as a function of ROI height

Height	Frame rate (fps)	Height	Frame rate (fps)
1216	32.3	200	169.8
1080	36.3	100	292.0
1024	38.2	50	456.0
960	40.6	20	687.8
768	50.3	12	795.7
600	63.5	4	943.7
480	78.2	2	989.8

Table 22: Mako G-234 12-bit sensor frame rate as a function of ROI height (Width=1936 pixels)

10-bit sensor readout

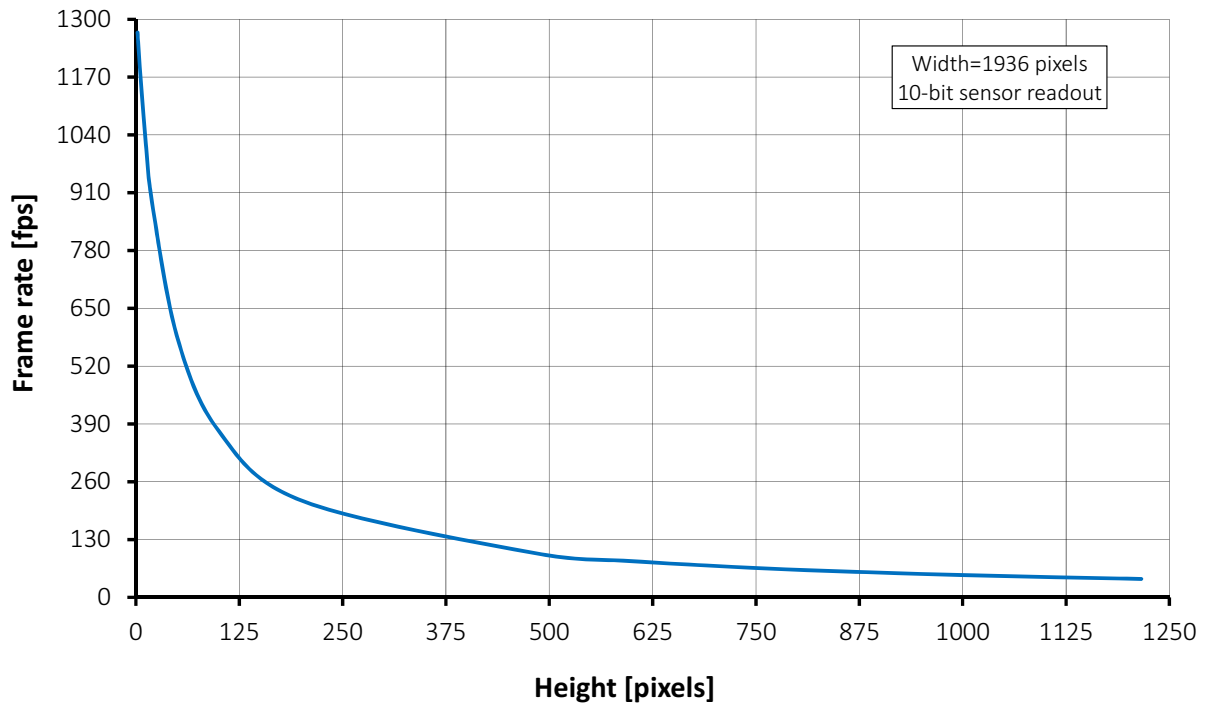

Figure 26: Mako G-234 10-bit sensor frame rate as a function of ROI height

Height	Frame rate (fps)	Height	Frame rate (fps)
1216	41.5	200	217.9
1080	46.5	100	374.7
1024	49.0	50	585.2
960	52.1	20	882.8
768	64.5	12	1021.2
600	81.5	4	1211.2
480	100.3	2	1270.3

Table 23: Mako G-234 10-bit sensor frame rate as a function of ROI height (Width=1936 pixels)

Mako G-319

The following table provides model specifications. The values are valid for Mako G-319B and G-319C models. For specifications common to all models, see [Specifications common to all models](#).

Feature	Specification	
	Mako G-319B	Mako G-319C
Sensor model	Sony IMX265LLR Exmor	Sony IMX265LQR Exmor
Resolution (H × V)	2064 × 1544; 3.2 MP	
Sensor type	CMOS	
Shutter type	Pregius global shutter	
Sensor format	Type 1/1.8	
Sensor size	8.9 mm diagonal	
Pixel size	3.45 μm × 3.45 μm	
Chief ray angle ¹	0 deg	
Maximum frame rate at full resolution	37.6 fps (39.5 fps burst mode)	
Maximum image bit depth	12-bit	
Image buffer	64 MB	
StreamHoldCapacity	Up to 20 frames at full resolution	
Monochrome pixel formats	Mono8, Mono12Packed, Mono12	Mono8
YUV color pixel formats	Not applicable	YUV411Packed, YUV422Packed, YUV444Packed
RGB color pixel formats	Not applicable	RGB8Packed, BGR8Packed
RAW pixel formats	Not applicable	BayerRG8, BayerRG12, BayerRG12Packed
Exposure time control ²	16 μs to 85.89 s; 1 μs increments	
Gain control	0 to 40 dB; 0.1 dB increments	
Binning	Horizontal: 1 to 4 pixels Vertical: 1 to 4 rows	Horizontal: 1 to 4 pixels
Decimation	Horizontal and Vertical: 1, 2, 4, 8 factor	
Power consumption	2.5 W at 12 VDC; 2.7 W PoE	

¹ For more information on chief ray angle, contact Allied Vision support.

² Whenever **PixelFormat** is changed, exposure adjusts itself to the nearest multiple of the exposure increment.

Table 24: Mako G-319 model specifications (sheet 1 of 2)

Feature	Specification	
	Mako G-319B	Mako G-319C
Trigger latency ³	Pixel format	Value
	Mono8, Mono12Packed, BayerRG8 BayerRG12Packed, YUV411Packed	48 μ s
	Mono12, BayerRG12, YUV422Packed	63.84 μ s
	RGB8Packed, BGR8Packed, YUV444Packed	96 μ s
Trigger jitter ³	Pixel format	Value
	Mono8, Mono12Packed, BayerRG8 BayerRG12Packed, YUV411Packed	\pm 8 μ s
	Mono12, BayerRG12, YUV422Packed	\pm 10.64 μ s
	RGB8Packed, BGR8Packed, YUV444Packed	\pm 16 μ s
Time between exposures	Pixel format	Value
	Mono8, Mono12Packed, BayerRG8 BayerRG12Packed, YUV411Packed	227 μ s
	Mono12, BayerRG12, YUV422Packed	306 μ s
	RGB8Packed, BGR8Packed, YUV444Packed	467 μ s

³ These values are calculated directly from the microcontroller source. There is no differentiation between Idle and Frame valid states for this sensor.

Table 24: Mako G-319 model specifications (sheet 2 of 2)

Absolute QE

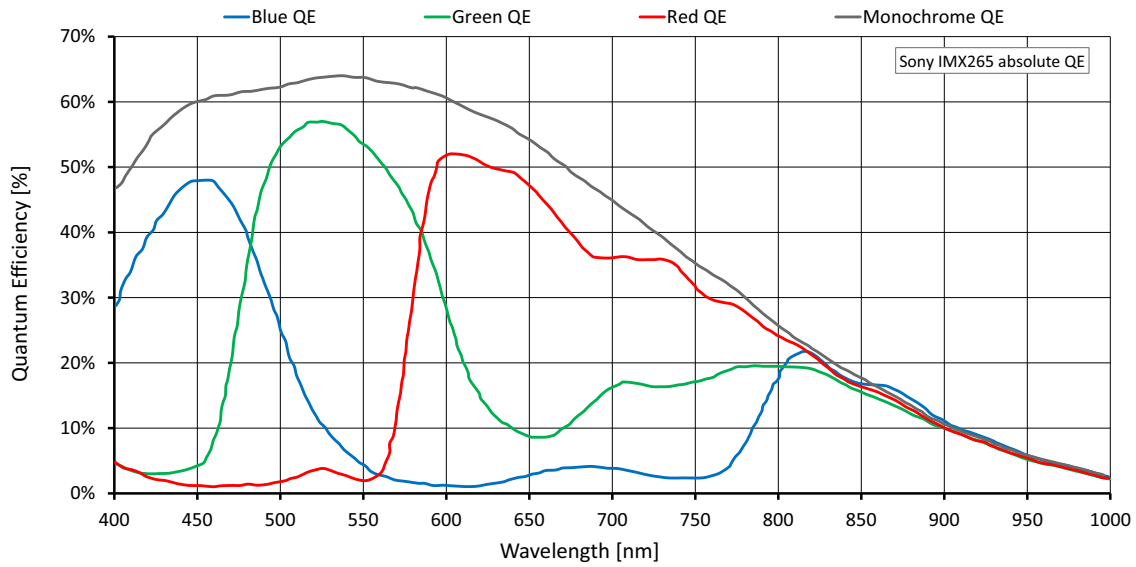

Figure 27: Mako G-319 (Sony IMX265) absolute QE

Spectral response

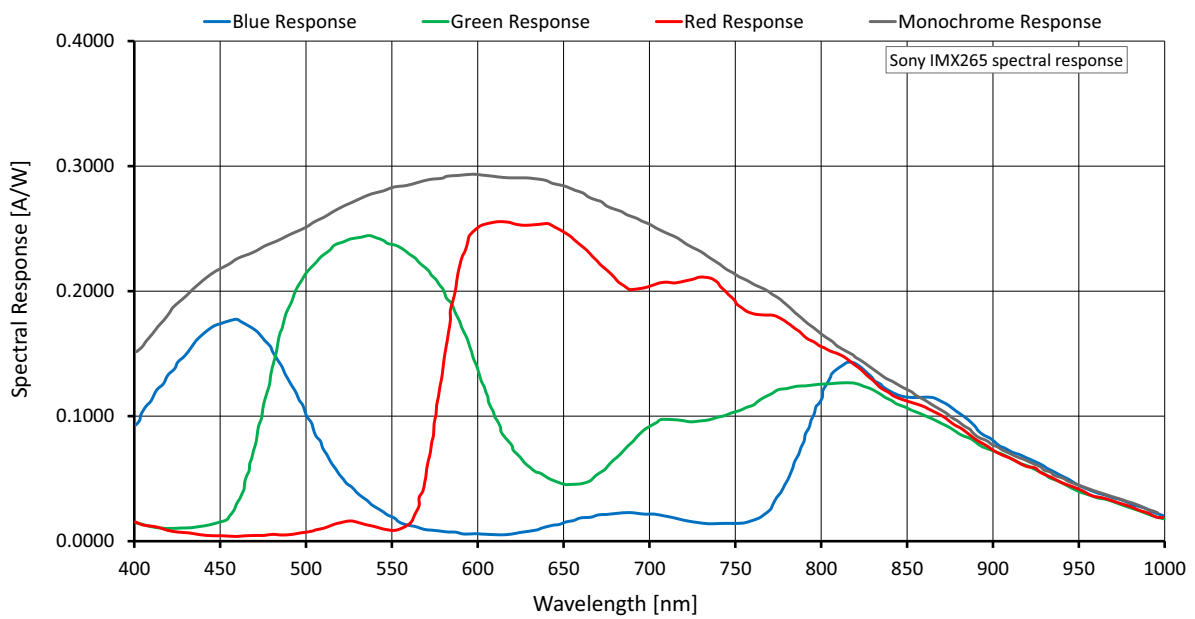

Figure 28: Mako G-319 (Sony IMX265) spectral response

ROI frame rate

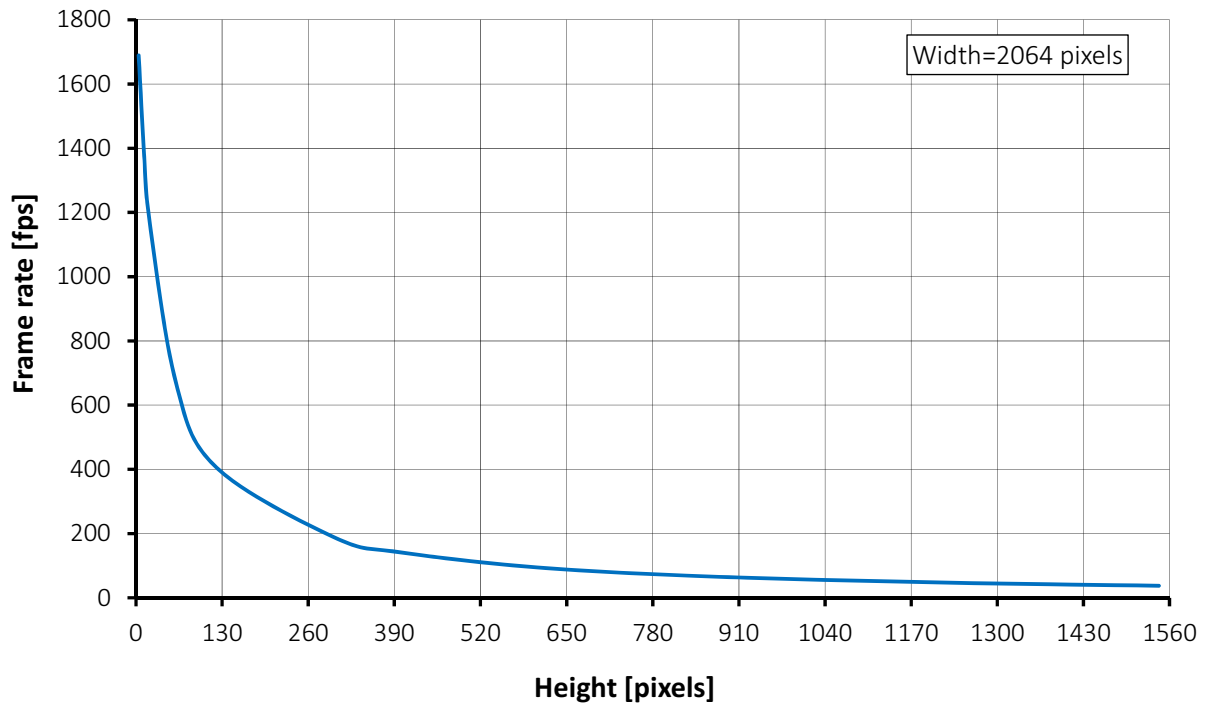

Figure 29: Mako G-319 frame rate as a function of ROI height

Height	Frame rate (fps)	Height	Frame rate (fps)
1544	37.6	300	187.7
1280	45.2	120	408.5
1024	56.5	60	672.0
800	71.9	20	1179.2
600	95.4	12	1388.9
400	141.4	4	1689.2

Table 25: Frame rate as a function of ROI height (Width=2064 pixels)



There is an increase in frame rate with reduced width if the camera is bandwidth limited. Reducing the exposure time may result in higher frame rates.

Mako G-419

The following table provides model specifications. The values are valid for Mako G-419B, G-419B NIR, and G-419C models. For specifications common to all models, see [Specifications common to all models](#).

Feature	Specification	
	Mako G-419B, G-419B NIR	Mako G-419C
Sensor model	CMOSIS/ams CMV4000	
Resolution (H × V)	2048 × 2048; 4.2 MP	
Sensor type	CMOS	
Shutter type	Global shutter	
Sensor format	Type 1	
Sensor size	16.0 mm diagonal	
Pixel size	5.5 μm × 5.5 μm	
Maximum frame rate at full resolution	26.3 fps	
Maximum image bit depth	12-bit	
Image buffer	64 MB	
StreamHoldCapacity	Up to 15 frames at full resolution	
Monochrome pixel formats	Mono8, Mono12Packed, Mono12	Mono8
YUV color pixel formats	Not applicable	YUV411Packed, YUV422Packed, YUV444Packed
RGB color pixel formats	Not applicable	RGB8Packed, BGR8Packed
RAW pixel formats	Not applicable	BayerGB8, BayerGB12, BayerGB12Packed
Exposure time control ¹	41 μs to 153 s; 1 μs increments	
Gain control	0 to 26 dB; 1 dB increments	
Power consumption	2.3 W at 12 VDC; 2.7 W PoE	
Trigger latency	3.48 μs	
Trigger jitter	±0.15 μs	
Time between exposures	Pixel format	Value
	Mono8, Mono12Packed, BayerGB8, BayerGB12Packed, YUV411Packed	130 μs

¹ Camera firmware version ≤ 01.52.8151 shows minimum exposure values without frame overhead time; 1 μs. See the sensor data sheet for details on frame overhead time.

² Trigger latency and trigger jitter values were measured at the external I/O (8-bit pixel format).

Table 26: Mako G-419 model specifications

Absolute QE

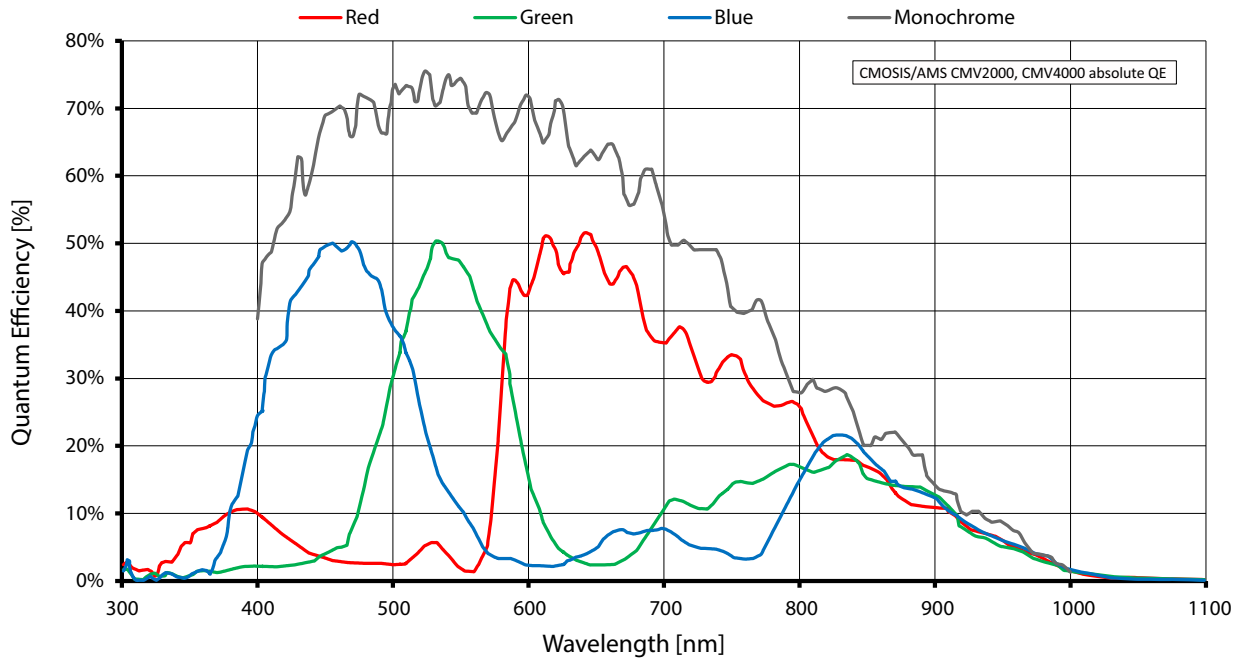

Figure 30: Mako G-419 (CMOSIS/ams CMV4000) absolute QE

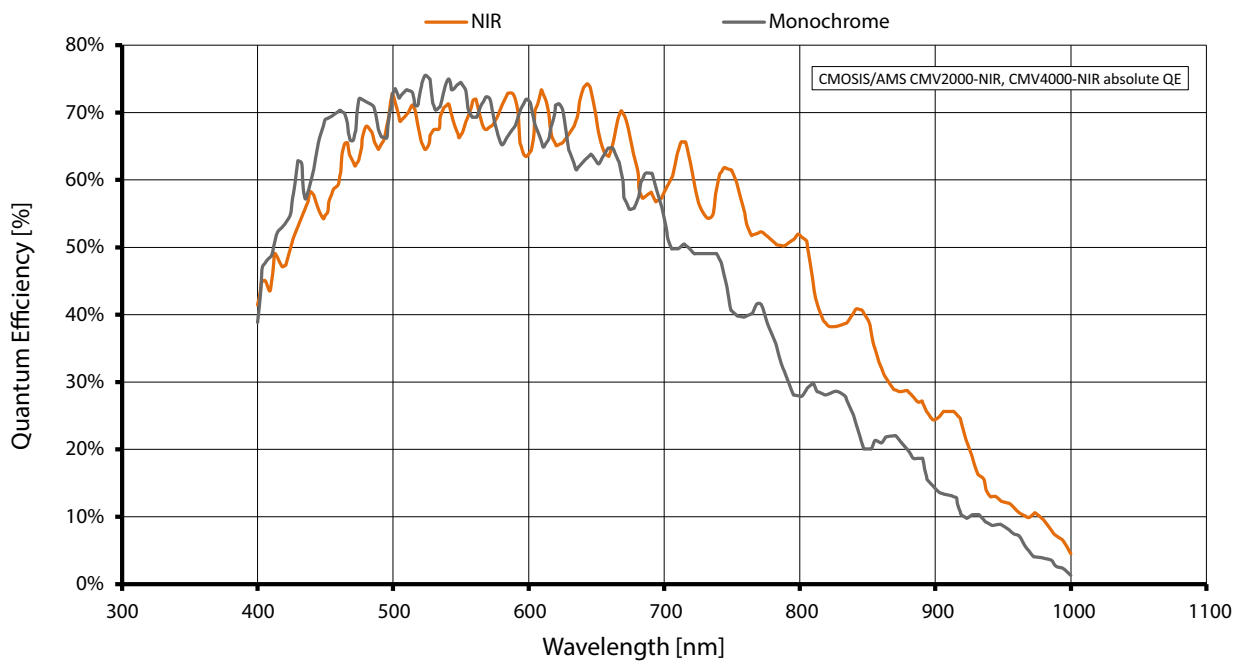

Figure 31: Mako G-419B NIR (CMOSIS/ams CMV4000) absolute QE

Spectral response

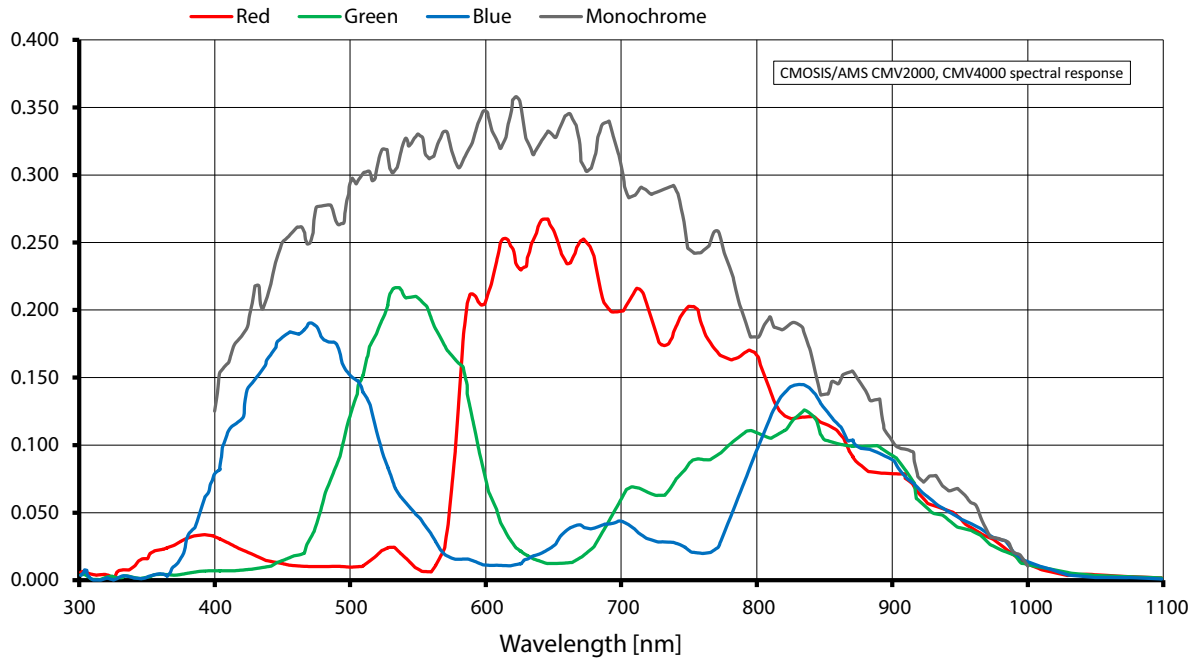

Figure 32: Mako G-419 (CMOSIS/ams CMV4000) spectral response

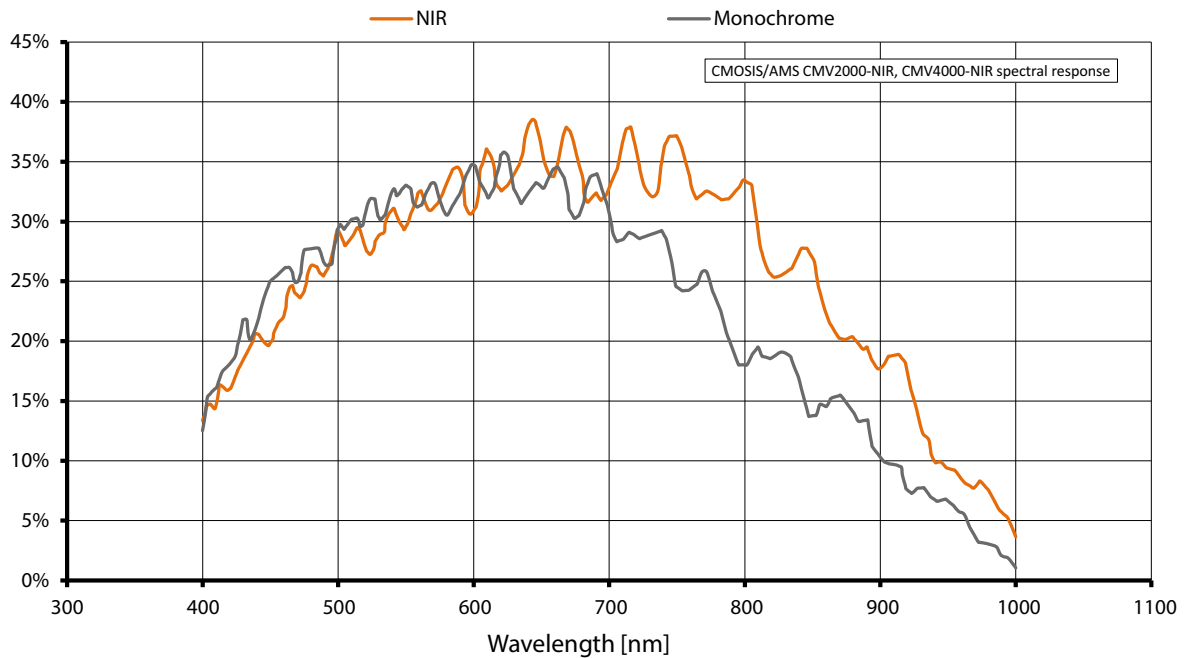

Figure 33: Mako G-419B NIR (CMOSIS/ams CMV4000) spectral response

ROI frame rate

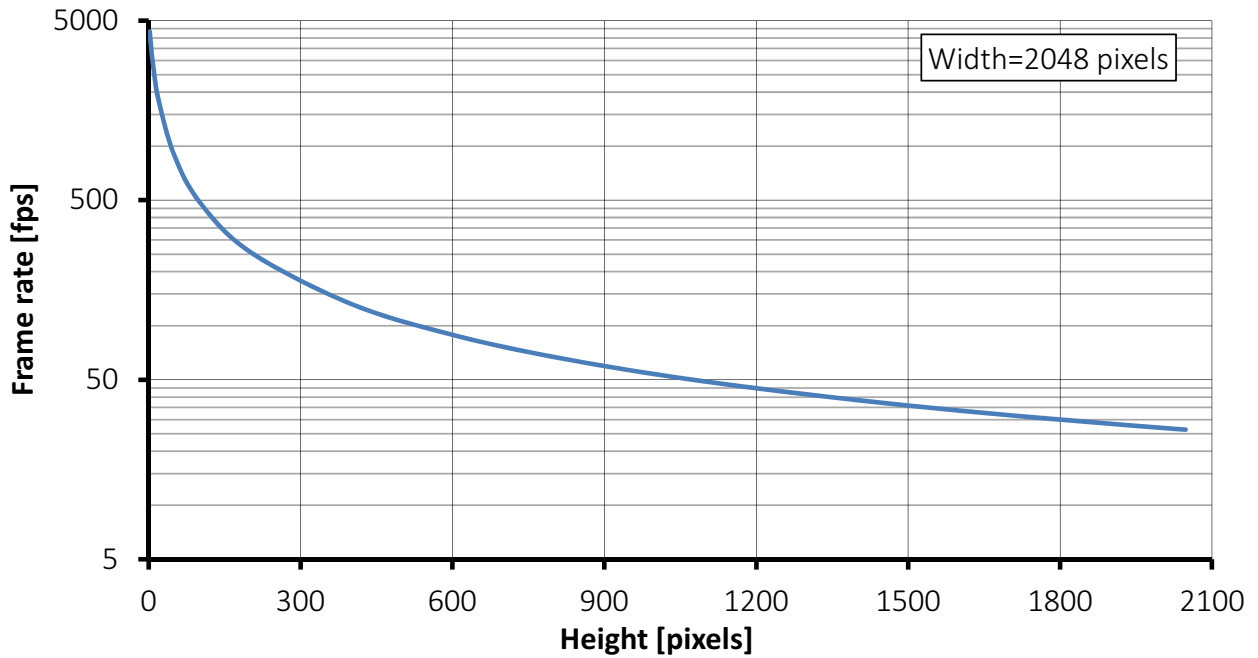

Figure 34: Mako G-419 frame rate as a function of ROI height

Height	Frame rate (fps)	Height	Frame rate (fps)
2048	26.3	400	132.1
2000	26.9	200	257.7
1800	29.9	100	490.8
1600	33.6	50	895.9
1400	38.4	20	1775.5
1200	44.8	10	2639.2
1000	53.7	5	3486.7
800	66.9	2	4342.1
600	88.8		

Table 27: Frame rate as a function of ROI height (Width=2048 pixels)



There is an increase in frame rate with reduced width if the camera is bandwidth limited.

Mako G-507

The following table provides model specifications. The values are valid for Mako G-507B and G-507C models. For specifications common to all models, see [Specifications common to all models](#).

Feature	Specification	
	Mako G-507B	Mako G-507C
Sensor model	Sony IMX264LLR Exmor	Sony IMX264LQR Exmor
Resolution (H × V)	2464 × 2056; 5.1 MP	
Sensor type	CMOS	
Shutter type	Pregius global shutter	
Sensor format	Type 2/3	
Sensor size	11.1 mm diagonal	
Pixel size	3.45 μm × 3.45 μm	
Chief ray angle ¹	0 deg	
Maximum frame rate at full resolution	23.7 fps (25.3 fps burst mode)	
Maximum image bit depth	12-bit	
Image buffer	64 MB	
StreamHoldCapacity	Up to 13 frames at full resolution	
Monochrome pixel formats	Mono8, Mono12Packed, Mono12	Mono8
YUV color pixel formats	Not applicable	YUV411Packed, YUV422Packed, YUV444Packed
RGB color pixel formats	Not applicable	RGB8Packed, BGR8Packed
RAW pixel formats	Not applicable	BayerRG8, BayerRG12, BayerRG12Packed
Exposure time control ²	16 μs to 85.89 s; 1 μs increments	
Gain control	0 to 40 dB; 0.1 dB increments	
Binning	Horizontal: 1 to 4 pixels Vertical: 1 to 4 rows	Horizontal: 1 to 4 pixels
Decimation	Horizontal and Vertical: 1, 2, 4, 8 factor	
Power consumption	2.4 W at 12 VDC; 2.8 W PoE	

¹ For more information on chief ray angle, contact Allied Vision support.

² Whenever pixel format is changed, exposure adjusts itself to the nearest multiple of the exposure increment.

Table 28: Mako G-507 model specifications (sheet 1 of 2)

Feature	Specification	
	Mako G-507B	Mako G-507C
Trigger latency ³	Pixel format	Value
	Mono8, Mono12Packed, BayerRG8 BayerRG12Packed, YUV411Packed	56.64 μ s
	Mono12, BayerRG12, YUV422Packed	75.36 μ s
	RGB8Packed, BGR8Packed, YUV444Packed	113.28 μ s
Trigger jitter ³	Pixel format	Value
	Mono8, Mono12Packed, BayerRG8 BayerRG12Packed, YUV411Packed	\pm 9.44 μ s
	Mono12, BayerRG12, YUV422Packed	\pm 12.56 μ s
	RGB8Packed, BGR8Packed, YUV444Packed	\pm 18.88 μ s
Time between exposures	Pixel format	Value
	Mono8, Mono12Packed, BayerRG8 BayerRG12Packed, YUV411Packed	270 μ s
	Mono12, BayerRG12, YUV422Packed	363 μ s
	RGB8Packed, BGR8Packed, YUV444Packed	554 μ s

³ These values are calculated directly from the microcontroller source. There is no differentiation between Idle and Frame valid states for this sensor.

Table 28: Mako G-507 model specifications (sheet 2 of 2)

Absolute QE

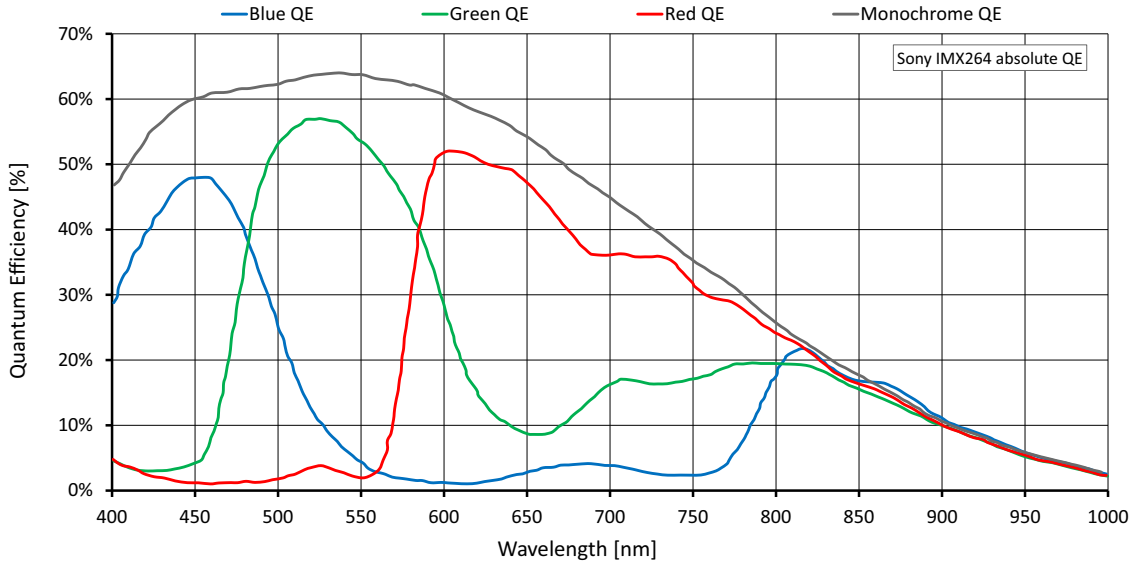

Figure 35: Mako G-507 (Sony IMX264) absolute QE

Spectral response

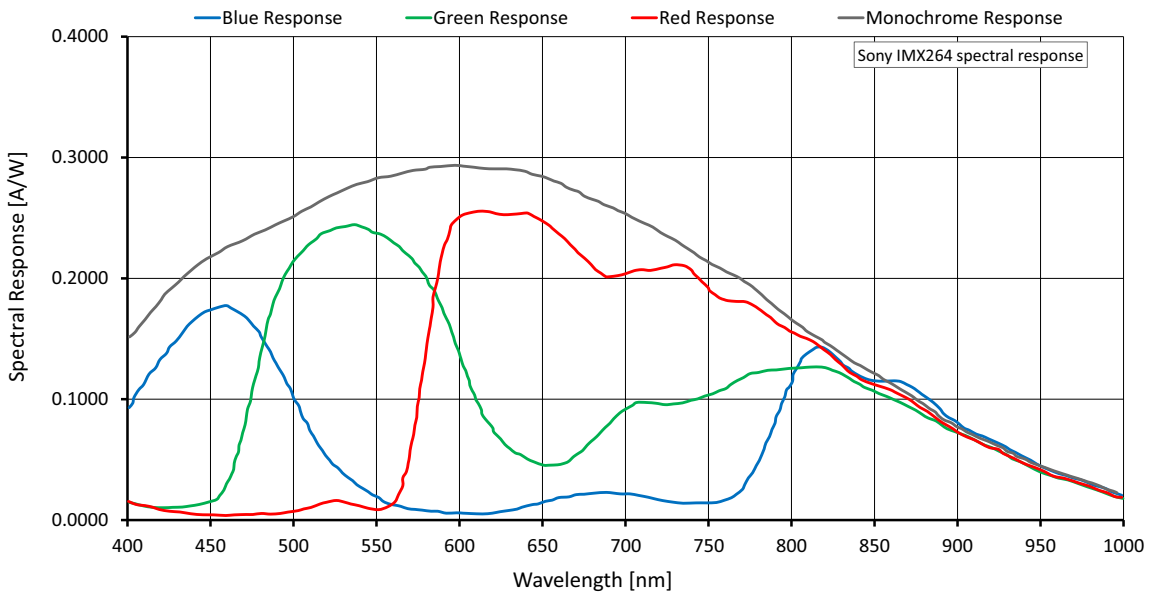

Figure 36: Mako G-507 (Sony IMX264) spectral response

ROI frame rate

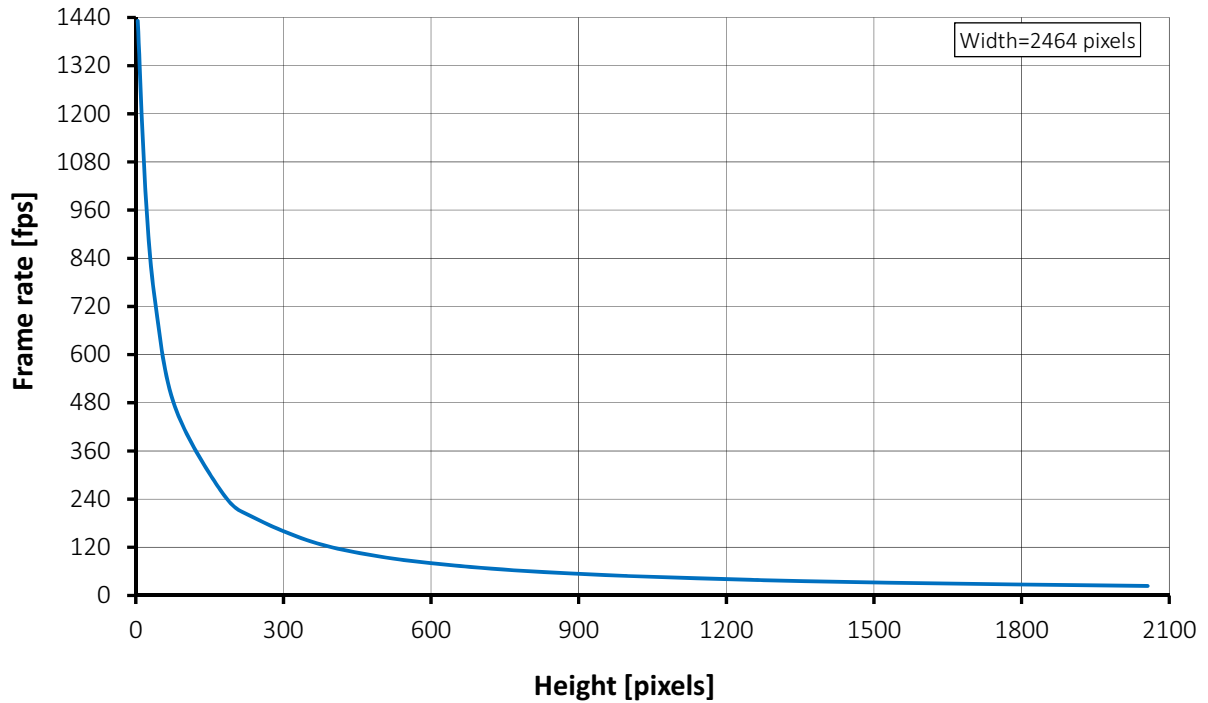

Figure 37: Mako G-507 frame rate as a function of ROI height

Height	Frame rate (fps)	Height	Frame rate (fps)
2056	23.7	480	100.3
1544	31.5	360	133.0
1324	36.8	240	194.0
1280	38.0	180	248.7
1024	47.4	80	468.7
960	50.6	40	725.5
768	62.9	20	999.3
600	80.6	4	1431.4

Table 29: Frame rate as a function of ROI height (Width=2464 pixels)



There is an increase in frame rate with reduced width if the camera is bandwidth limited. Reducing the exposure time may result in higher frame rates.

Mako G-508B POL

The following table provides model specifications for Mako G-508B POL. For specifications common to all models, see [Specifications common to all models](#).

Feature	Specification	
Sensor model	Sony IMX250MZR Polarsens	
Resolution (H × V)	2464 × 2056; 5.0 MP	
Sensor type	CMOS	
Shutter type	Pregius global shutter	
Sensor format	Type 2/3	
Sensor size	11.1 mm diagonal	
Pixel size	3.45 μm × 3.45 μm	
Chief ray angle ¹	0 deg	
Maximum frame rate at full resolution	23.7 fps (25.3 fps burst mode)	
Maximum image bit depth	12-bit	
Image buffer	64 MB	
StreamHoldCapacity	Up to 13 frames at full resolution	
Monochrome pixel formats	Mono8, Mono12Packed, Mono12	
Exposure time control ²	16 μs to 85.89 s; 1 μs increments	
Gain control	0 to 40 dB; 0.1 dB increments	
Binning	Horizontal: 1 to 4 pixels; Vertical: 1 to 4 rows	
Decimation	Horizontal and Vertical: 1, 2, 4, 8 factor	
Power consumption	2.4 W at 12 VDC; 2.8 W PoE	
Trigger latency ³	Pixel format	Value
	Mono8, Mono12Packed	56.64 μs
	Mono12	75.36 μs
Trigger jitter ³	Pixel format	Value
	Mono8, Mono12Packed	±9.44 μs
	Mono12	±12.56 μs
Time between exposures	Pixel format	Value
	Mono8, Mono12Packed	270 μs
	Mono12	363 μs

¹ For more information on chief ray angle, contact Allied Vision support.

² Whenever pixel format is changed, exposure adjusts itself to the nearest multiple of the exposure increment.

³ These values are calculated directly from the microcontroller source. There is no differentiation between Idle and Frame valid states for this sensor.

Table 30: Mako G-508B POL model specifications

Absolute QE

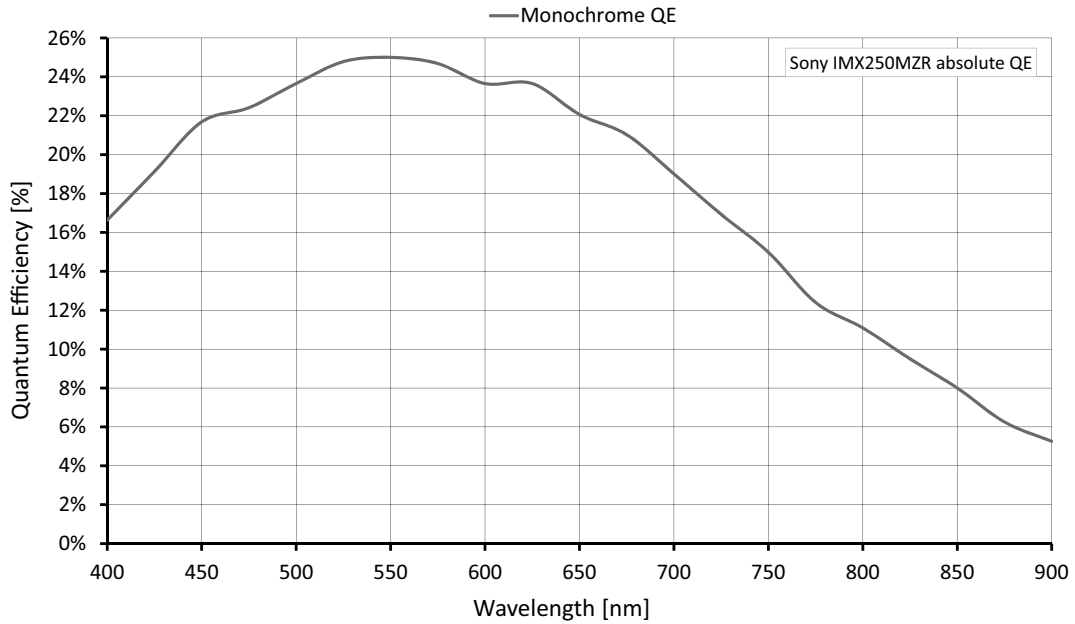

*Note: The quantum efficiency depends on the illumination's degree of polarization.

Figure 38: Mako G-508B POL (Sony IMX250MZR) absolute QE

Relative spectral response

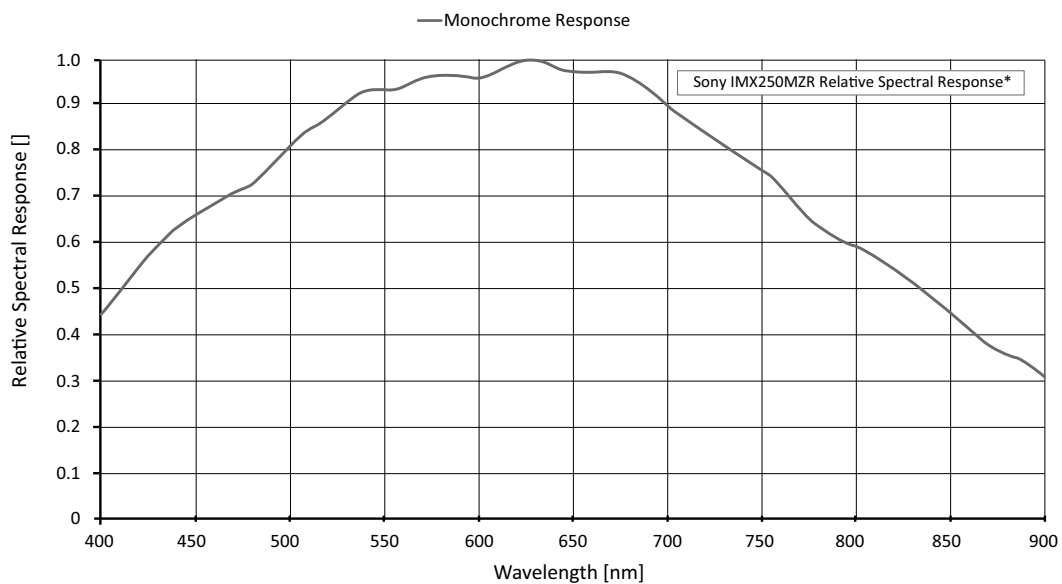

*Note: The spectral response depends on the illumination's degree of polarization.

Figure 39: Mako G-508B POL (Sony IMX250MZR) relative spectral response

Polarization coding diagram

The four-directional polarization of the Sony IMX250MZR sensor is arranged to get transmitted light in the layout shown in the figure below. The 90 degree signal and 45 degree signal lines, and the 135 degree signal and 0 degree signal lines are output successively.

90	45	90	45
135	0	135	0
90	45	90	45
135	0	135	0

Polarization Coding Diagram

Figure 40: Polarization coding of physical pixel array

ROI frame rate

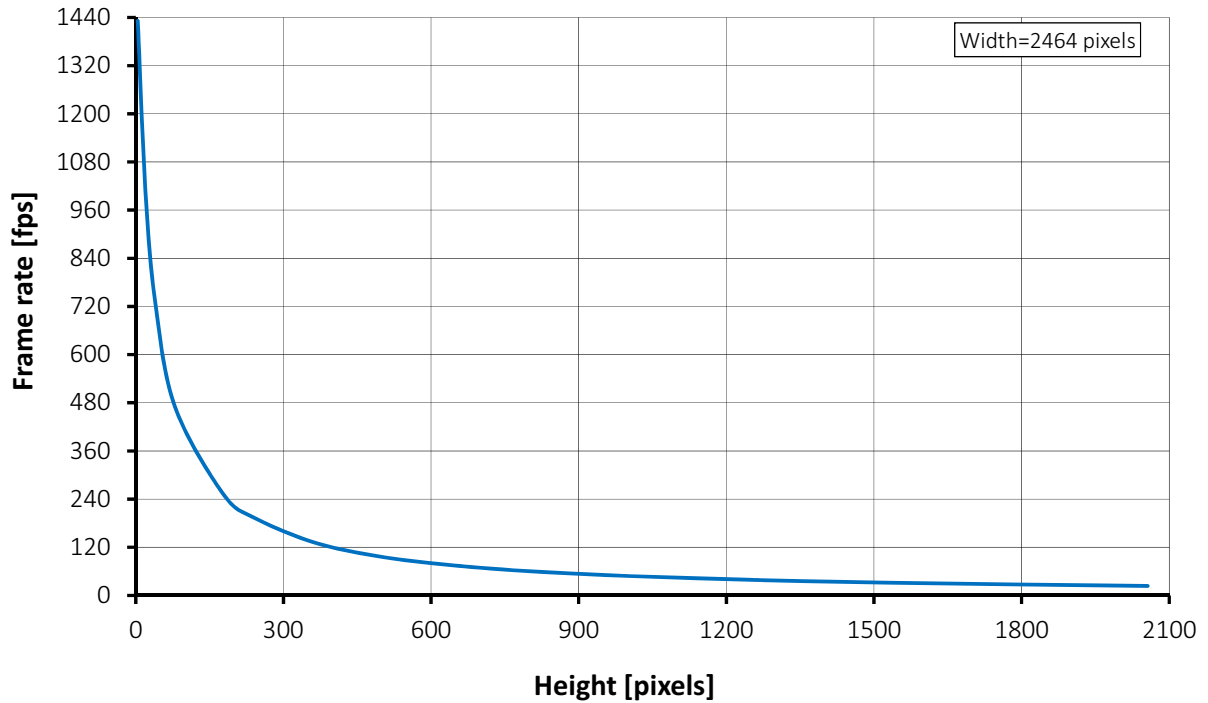

Figure 41: Mako G-508B POL frame rate as a function of ROI height

Height	Frame rate (fps)	Height	Frame rate (fps)
2056	23.7	480	100.3
1544	31.5	360	133.0
1324	36.8	240	194.0
1280	38.0	180	248.7
1024	47.4	80	468.7
960	50.6	40	725.5
768	62.9	20	999.3
600	80.6	4	1431.4

Table 31: Frame rate as a function of ROI height (Width=2464 pixels)



There is an increase in frame rate with reduced width if the camera is bandwidth limited. Reducing the exposure time may result in higher frame rates.

Mako G-511

The following table provides model specifications. The values are valid for Mako G-511B and G-511C models. For specifications common to all models, see [Specifications common to all models](#).

Feature	Specification	
	Mako G-511B	Mako G-511C
Sensor model	Sony IMX547-AAMJ-C	Sony IMX547-AAQJ-C
Resolution	2472 (H) × 2064 (V); 5.1 MP	
Sensor type	CMOS	
Shutter type	Global shutter (GS)	
Sensor format	Type 1/1.8	
Sensor size	8.8 mm diagonal	
Pixel size	2.74 μm × 2.74 μm	
Chief ray angle ¹	0 deg	
Maximum frame rate at full resolution	23 fps (23 fps burst mode)	
Maximum image bit depth	12-bit	
Image buffer	64 MB	
StreamHoldCapacity	Up to 12 frames at full resolution	
Monochrome pixel formats	Mono8, Mono12Packed, Mono12	Mono8
YUV color pixel formats	Not applicable	YUV411Packed, YUV422Packed, YUV444Packed
RGB color pixel formats	Not applicable	RGB8Packed, BGR8Packed
RAW pixel formats	Not applicable	BayerRG8, BayerRG12, BayerRG12Packed
Exposure time control ²	4 μs to 114.5 s; 1 μs increments	
Gain control	0 to 40 dB; 0.1 dB increments	
Binning	Horizontal: 1 to 4 pixels Vertical (mono only): 1 to 4 rows	
Decimation	Horizontal and Vertical: 1, 2, 4, 8 factor	
Power consumption	3.2 W at 12 VDC; 2.7 W PoE	
¹ For more information on chief ray angle, contact Allied Vision support.		
² Common for all pixel formats.		

Table 32: Mako G-511 model specifications (sheet 1 of 2)

Feature	Specification	
	Mako G-511B	Mako G-511C
Trigger latency ³	Pixel format	Value
	Mono8, Mono12Packed, BayerRG8 BayerRG12Packed, YUV411Packed	137.39 μ s
	Mono12, BayerRG12, YUV422Packed	182.78 μ s
	RGB8Packed, BGR8Packed, YUV444Packed	274.77 μ s
Trigger jitter ³	Pixel format	Value
	Mono8, Mono12Packed, BayerRG8 BayerRG12Packed, YUV411Packed	\pm 9.81 μ s
	Mono12, BayerRG12, YUV422Packed	\pm 13.06 μ s
	RGB8Packed, BGR8Packed, YUV444Packed	\pm 19.63 μ s
Time between exposures	Pixel format	Value
	Mono8, Mono12Packed, BayerRG8 BayerRG12Packed, YUV411Packed	685 μ s
	Mono12, BayerRG12, YUV422Packed	913 μ s
	RGB8Packed, BGR8Packed, YUV444Packed	1372 μ s

³ These values are calculated directly from the microcontroller source. There is no differentiation between Idle and Frame valid states for this sensor.

Table 32: Mako G-511 model specifications (sheet 2 of 2)

Absolute QE

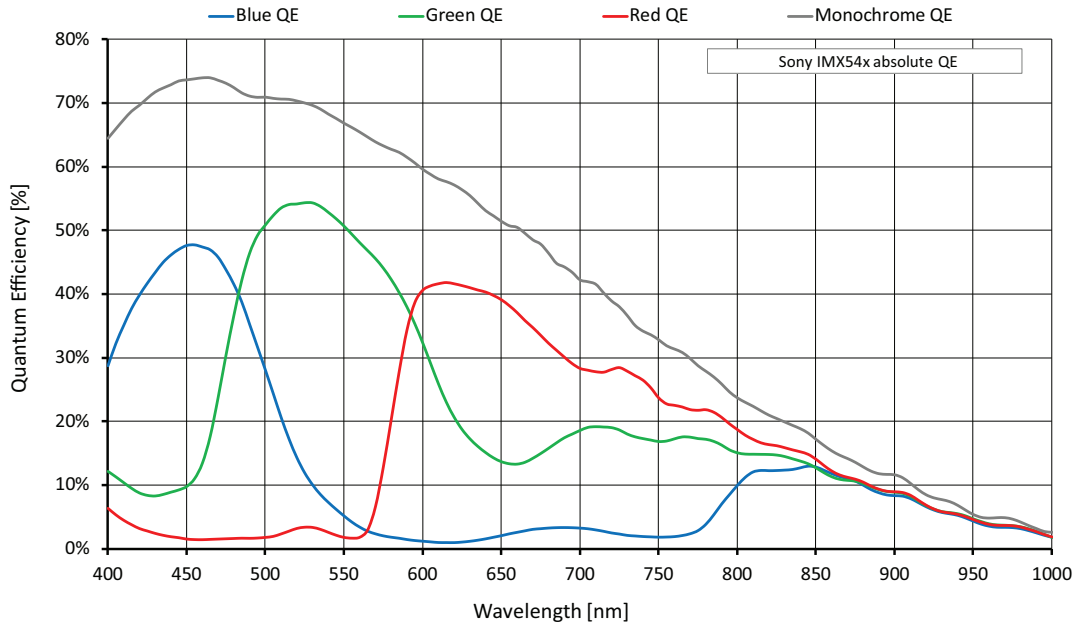

Figure 42: Mako G-511 (Sony IMX547) absolute QE

Spectral response

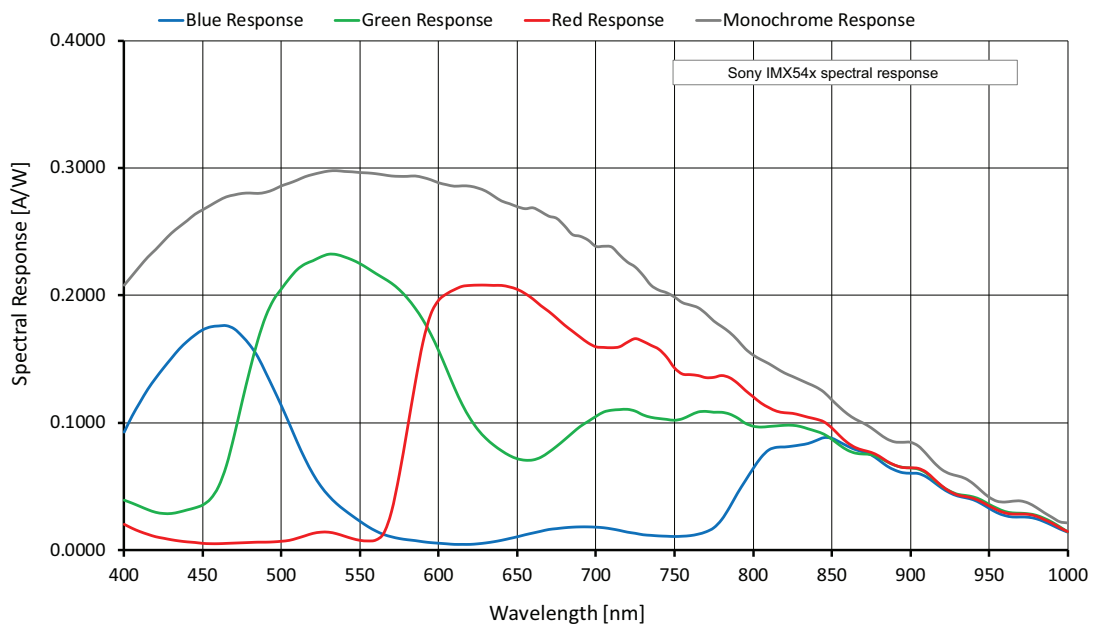

Figure 43: Mako G-511 (Sony IMX547) spectral response

ROI frame rate

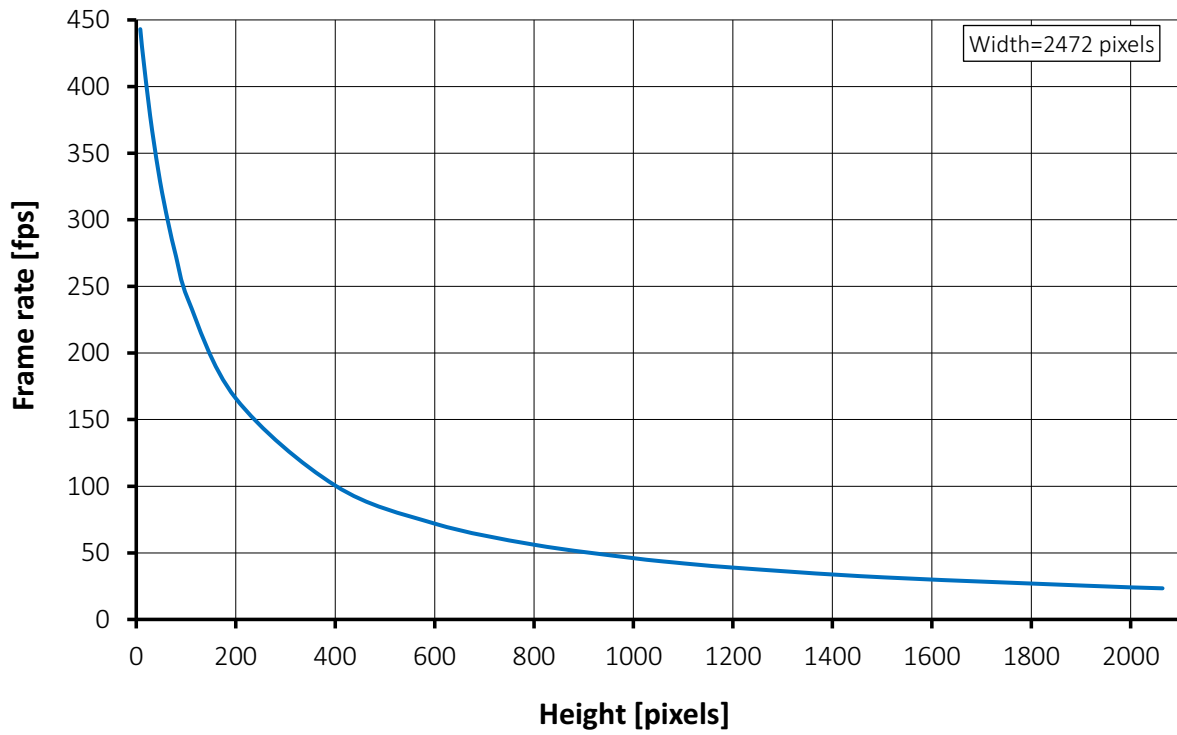

Figure 44: Mako G-511 frame rate as a function of ROI height

Height	Frame rate (fps)	Height	Frame rate (fps)
2064	23.4	200	165.9
2000	24.1	104	240.3
1504	31.6	80	272.5
1200	38.9	64	298
1080	42.9	48	328.7
1000	46	32	366.6
800	56.1	16	414.3
600	72	8	443.1
400	100.5		

Table 33: Frame rate as a function of ROI height (Width=2472 pixels)



There is an increase in frame rate with reduced width if the camera is bandwidth limited. Reducing the exposure time may result in higher frame rates.

Mako G-811

The following table provides model specifications. The values are valid for Mako G-811B and G-811C models. For specifications common to all models, see [Specifications common to all models](#).

Feature	Specification	
	Mako G-811B	Mako G-811C
Sensor model	Sony IMX546-AAMJ-C	Sony IMX546-AAQJ-C
Resolution	2856 (H) × 2848 (V); 8.1 MP	
Sensor type	CMOS	
Shutter type	Global shutter (GS)	
Sensor format	Type 2/3	
Sensor size	11.1 mm diagonal	
Pixel size	2.74 μm × 2.74 μm	
Chief ray angle ¹	0 deg	
Maximum frame rate at full resolution	14.7 fps (15.1 fps burst mode)	
Maximum image bit depth	12-bit	
Image buffer	64 MB	
StreamHoldCapacity	Up to 8 frames at full resolution	
Monochrome pixel formats	Mono8, Mono12Packed, Mono12	Mono8
YUV color pixel formats	Not applicable	YUV411Packed, YUV422Packed, YUV444Packed
RGB color pixel formats	Not applicable	RGB8Packed, BGR8Packed
RAW pixel formats	Not applicable	BayerRG8, BayerRG12, BayerRG12Packed
Exposure time control ²	4 μs to 114.5 s; 1 μs increments	
Gain control	0 to 40 dB; 0.1 dB increments	
Binning	Horizontal: 1 to 4 pixels Vertical (mono only): 1 to 4 rows	
Decimation	Horizontal and Vertical: 1, 2, 4, 8 factor	
Power consumption	3.3 W at 12 VDC; 2.8 W PoE	
¹ For more information on chief ray angle, contact Allied Vision support.		
² Common for all pixel formats.		

Table 34: Mako G-811 model specifications (sheet 1 of 2)

Feature	Specification	
	Mako G-811B	Mako G-811C
Trigger latency ³	Pixel format	Value
	Mono8, Mono12Packed, BayerRG8 BayerRG12Packed, YUV411Packed	156.8 μ s
	Mono12, BayerRG12, YUV422Packed	208.62 μ s
	RGB8Packed, BGR8Packed, YUV444Packed	313.6 μ s
Trigger jitter ³	Pixel format	Value
	Mono8, Mono12Packed, BayerRG8 BayerRG12Packed, YUV411Packed	\pm 11.2 μ s
	Mono12, BayerRG12, YUV422Packed	\pm 14.9 μ s
	RGB8Packed, BGR8Packed, YUV444Packed	\pm 22.4 μ s
Time between exposures	Pixel format	Value
	Mono8, Mono12Packed, BayerRG8 BayerRG12Packed, YUV411Packed	782 μ s
	Mono12, BayerRG12, YUV422Packed	1040 μ s
	RGB8Packed, BGR8Packed, YUV444Packed	1566 μ s

³ These values are calculated directly from the microcontroller source. There is no differentiation between Idle and Frame valid states for this sensor.

Table 34: Mako G-811 model specifications (sheet 2 of 2)

Absolute QE

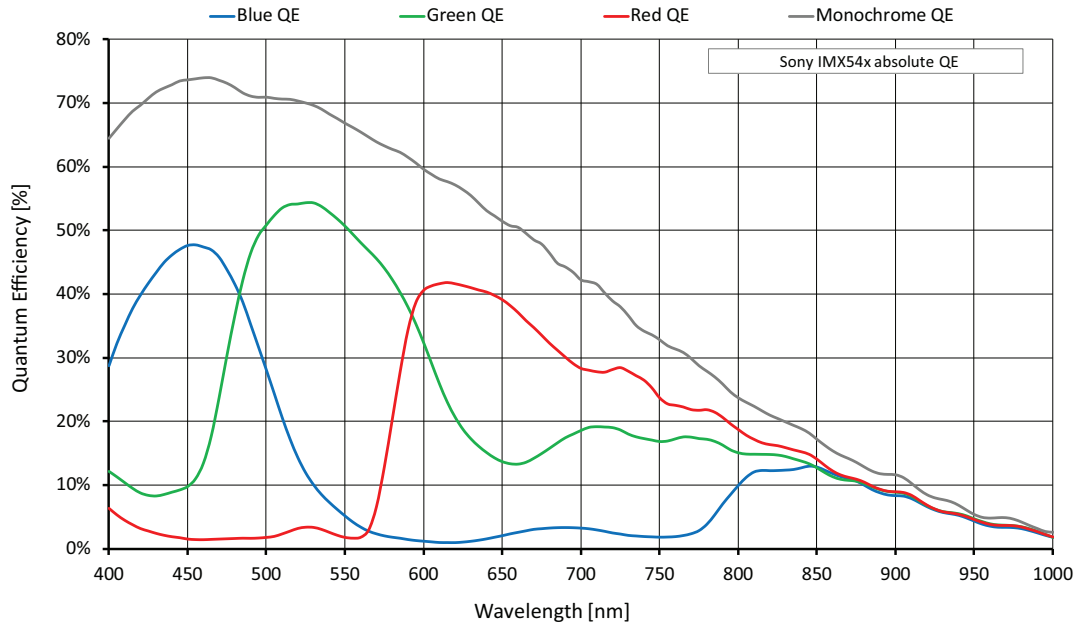

Figure 45: Mako G-811 (Sony IMX546) absolute QE

Spectral response

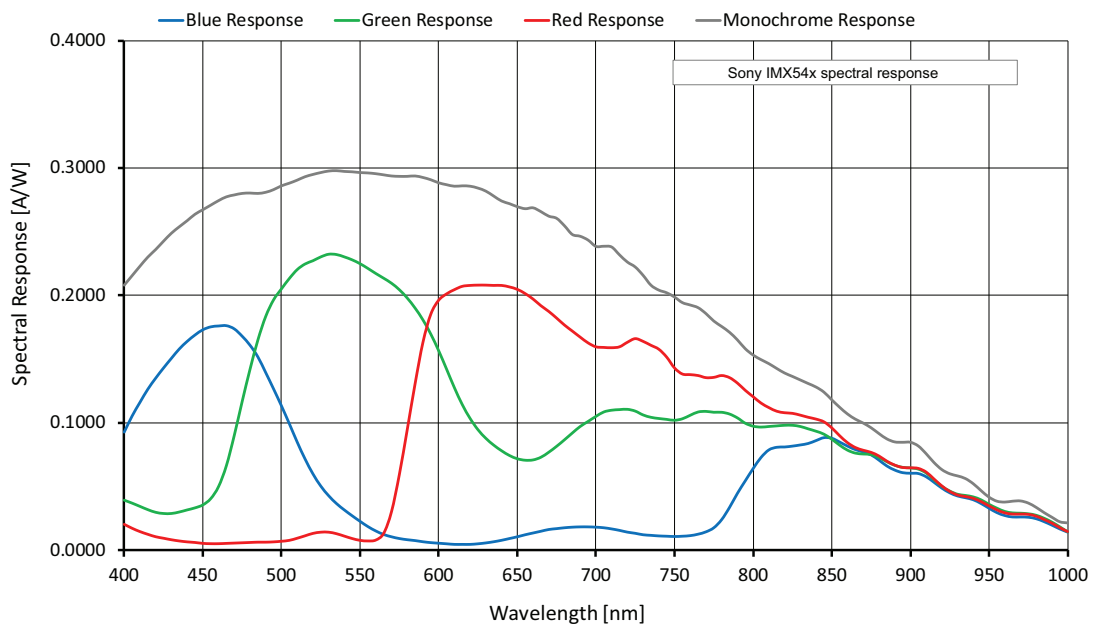

Figure 46: Mako G-811 (Sony IMX546) spectral response

ROI frame rate

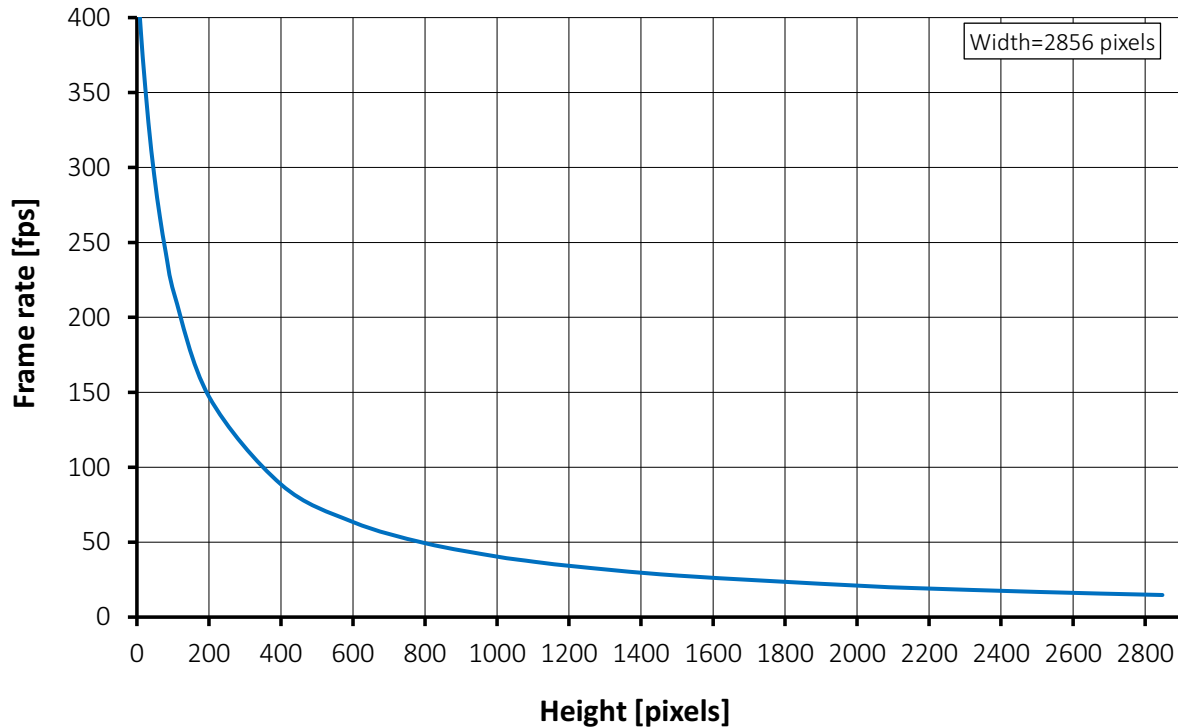

Figure 47: Mako G-811 frame rate as a function of ROI height

Height	Frame rate (fps)	Height	Frame rate (fps)
2848	14.7	400	88.6
2504	16.8	200	147.1
2160	19.4	104	215.2
2000	21	80	243.4
1504	27.7	64	266.7
1200	34.2	48	294.9
1080	37.7	32	329.8
1000	40.4	16	374
800	49.4	8	400.8
600	63.4		

Table 35: Frame rate as a function of ROI height (Width=2856 pixels)



There is an increase in frame rate with reduced width if the camera is bandwidth limited. Reducing the exposure time may result in higher frame rates.

Mako G-1242

The following table provides model specifications. The values are valid for Mako G-1242B and G-1242C models. For specifications common to all models, see [Specifications common to all models](#).

Feature	Specification	
	Mako G-1242B	Mako G-1242C
Sensor model	Sony IMX545-AAMJ-C	Sony IMX545-AAQJ-C
Resolution	4128 (H) × 3008 (V); 12.4 MP	
Sensor type	CMOS	
Shutter type	Global shutter (GS)	
Sensor format	Type 1/1.1	
Sensor size	14 mm diagonal	
Pixel size	2.74 μm × 2.74 μm	
Chief ray angle ¹	0 deg	
Maximum frame rate at full resolution	9.6 fps (10 fps burst mode)	
Maximum image bit depth	12-bit	
Image buffer	64 MB	
StreamHoldCapacity	Up to 5 frames at full resolution	
Monochrome pixel formats	Mono8, Mono12Packed, Mono12	Mono8
YUV color pixel formats	Not applicable	YUV411Packed, YUV422Packed, YUV444Packed
RGB color pixel formats	Not applicable	RGB8Packed, BGR8Packed
RAW pixel formats	Not applicable	BayerRG8, BayerRG12, BayerRG12Packed
Exposure time control ²	4 μs to 114.5 s; 1 μs increments	
Gain control	0 to 40 dB; 0.1 dB increments	
Binning	Horizontal: 1 to 4 pixels Vertical (mono only): 1 to 4 rows	
Decimation	Horizontal and Vertical: 1, 2, 4, 8 factor	
Power consumption	3.3 W at 12 VDC; 2.9 W PoE	
¹ For more information on chief ray angle, contact Allied Vision support.		
² Common for all pixel formats.		

Table 36: Mako G-1242 model specifications (sheet 1 of 2)

Feature	Specification	
	Mako G-1242B	Mako G-1242C
Trigger latency ³	Pixel format	Value
	Mono8, Mono12Packed, BayerRG8 BayerRG12Packed, YUV411Packed	224 μ s
	Mono12, BayerRG12, YUV422Packed	297.92 μ s
	RGB8Packed, BGR8Packed, YUV444Packed	448 μ s
Trigger jitter ³	Pixel format	Value
	Mono8, Mono12Packed, BayerRG8 BayerRG12Packed, YUV411Packed	\pm 16 μ s
	Mono12, BayerRG12, YUV422Packed	\pm 21.28 μ s
	RGB8Packed, BGR8Packed, YUV444Packed	\pm 32 μ s
Time between exposures	Pixel format	Value
	Mono8, Mono12Packed, BayerRG8 BayerRG12Packed, YUV411Packed	1118 μ s
	Mono12, BayerRG12, YUV422Packed	1488 μ s
	RGB8Packed, BGR8Packed, YUV444Packed	2238 μ s

³ These values are calculated directly from the microcontroller source. There is no differentiation between Idle and Frame valid states for this sensor.

Table 36: Mako G-1242 model specifications (sheet 2 of 2)

Absolute QE

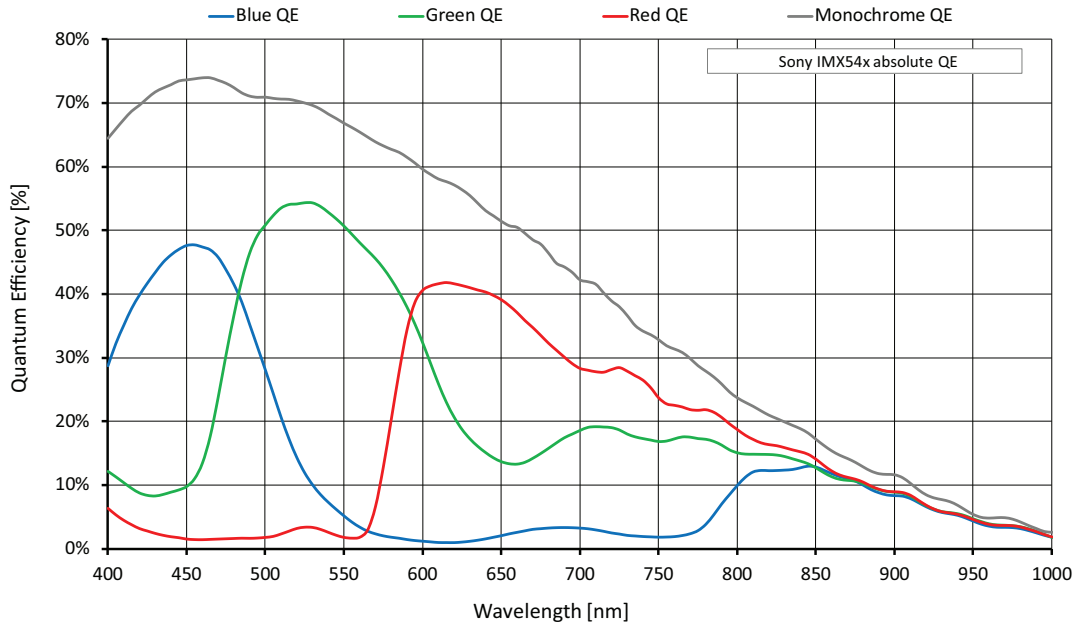

Figure 48: Mako G-1242 (Sony IMX545) absolute QE

Spectral response

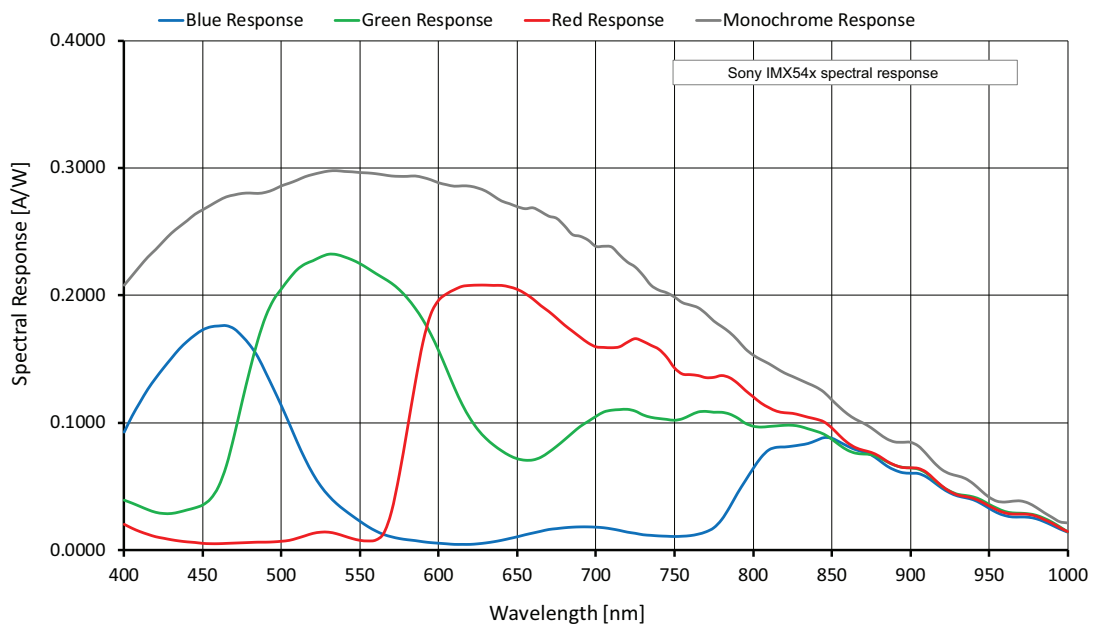

Figure 49: Mako G-1242 (Sony IMX545) spectral response

ROI frame rate

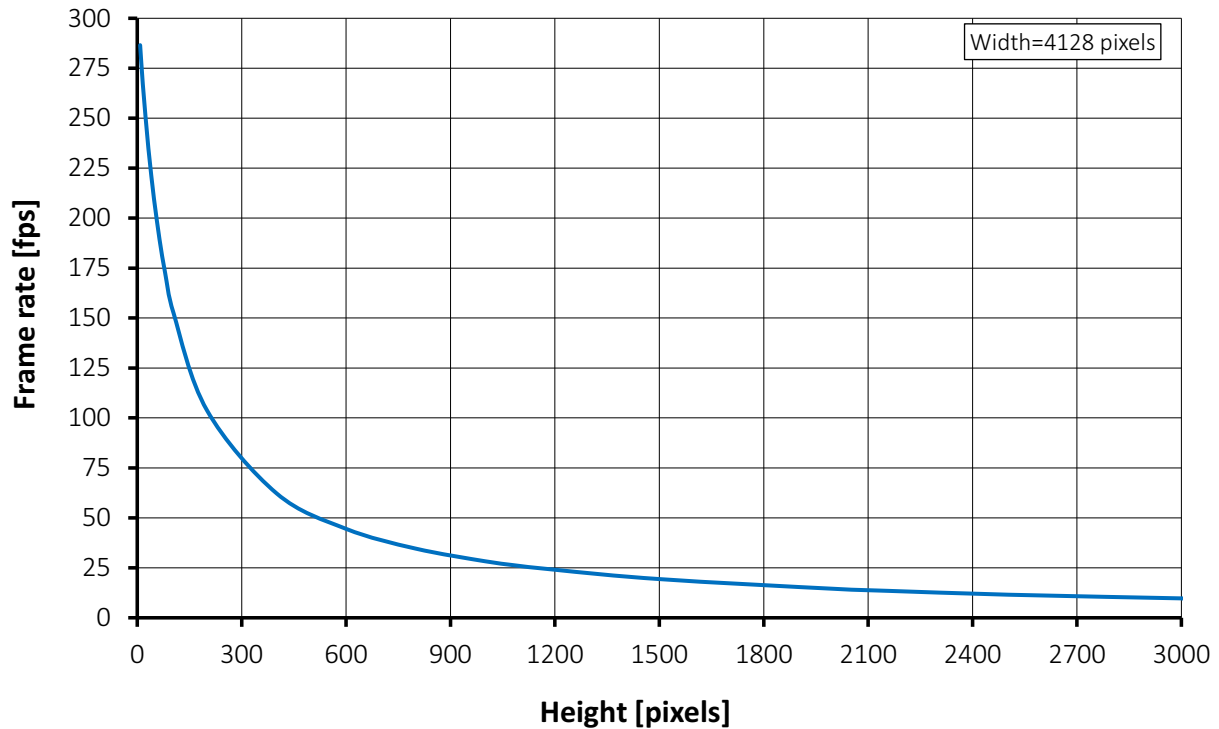

Figure 50: Mako G-1242 frame rate as a function of ROI height

Height	Frame rate (fps)	Height	Frame rate (fps)
3008	9.6	600	44.5
3000	9.7	400	62.3
2504	11.6	200	103.8
2160	13.5	104	152.4
2000	14.5	80	172.6
1504	19.3	64	189.3
1200	24	48	209.6
1080	26.4	32	234.8
1000	28.3	16	266.9
800	34.6	8	286.5

Table 37: Frame rate as a function of ROI height (Width=4128 pixels)



There is an increase in frame rate with reduced width if the camera is bandwidth limited. Reducing the exposure time may result in higher frame rates.

Camera feature availability

Mako cameras support a number of standard and extended features. The following table identifies a selection of capabilities and compares the availability of features in Mako camera models.

A complete listing of camera features, including definitions can be found on the Allied Vision Technical Documentation webpage.

- Vimba and third-party users: GigE Features Reference
- PvAPI users: GigE Camera and Driver Attributes document

Image optimization features	Mako G-032	Mako G-040	Mako G-125	Mako G-131	Mako G-158	Mako G-192	Mako G-223	Mako G-234	Mako G-319	Mako G-419	Mako G-507	Mako G-508	Mako G-511	Mako G-811	Mako G-1242
Auto exposure	✓	✓	✓	✓	✓	✓	✓	✓	✓	✓	✓	✓	✓	✓	✓
Auto gain	✓	✓	✓	✓	✓	✓	✓	✓	✓	✓	✓	✓	✓	✓	✓
Auto white balance ¹	✓	✓	✓	✓	✓	✓	✓	✓	✓	✓	✓	✓	✓	✓	✓
Binning: horizontal	✓	✓	✓	✓	✓	✓		✓	✓		✓	✓	✓	✓	✓
Binning: vertical	✓	✓	✓	✓	✓	✓		✓	✓ ²		✓ ²	✓	✓ ²	✓ ²	✓ ²
Black level	✓	✓	✓	✓	✓	✓	✓	✓	✓	✓	✓	✓	✓	✓	✓
Color transformation (incl. hue, saturation) ¹	✓	✓	✓	✓	✓	✓	✓	✓	✓	✓	✓		✓	✓	✓
Decimation		✓		✓	✓	✓		✓	✓		✓	✓	✓	✓	✓
Defect masking				✓		✓	✓			✓					
Gamma	✓	✓	✓	✓	✓	✓	✓	✓	✓	✓	✓	✓	✓	✓	✓
HDR mode							✓			✓					
LUT (look-up table)	✓	✓	✓	✓	✓	✓	✓	✓	✓	✓	✓	✓	✓	✓	✓ ²
Reverse X/Y		✓		✓	✓	✓		✓	✓		✓	✓	✓	✓	✓
ROI (region of interest)	✓	✓	✓	✓	✓	✓	✓	✓	✓	✓	✓	✓	✓	✓	✓
Sensor shutter mode ³	A	A	A	C	A	C	A	A	A	A	A	A	A	A	A
¹ Color models only															
² Monochrome models only															
³ Sensor shutter mode: (A) Global (B) Global Reset, Rolling (C) Global, Rolling, Global Reset															

Table 38: Image optimization feature availability by model

Camera control features	Mako G-032	Mako G-040	Mako G-125	Mako G-131	Mako G-158	Mako G-192	Mako G-223	Mako G-234	Mako G-319	Mako G-419	Mako G-507	Mako G-508	Mako G-511	Mako G-811	Mako G-1242
Action commands, incl. ToE (trigger over Ethernet)		✓			✓		✓	✓	✓	✓	✓	✓	✓	✓	✓
Event channel	✓	✓	✓	✓	✓	✓	✓	✓	✓	✓	✓	✓	✓	✓	✓
Image chunk data	✓	✓	✓	✓	✓	✓	✓	✓	✓	✓	✓	✓	✓	✓	✓
I/O and trigger control	✓	✓	✓	✓	✓	✓	✓	✓	✓	✓	✓	✓	✓	✓	✓
PTP (IEEE 1588 Precision Time Protocol)		✓			✓		✓	✓	✓	✓	✓	✓	✓	✓	✓
Readout modes (10/12 bit)								✓							
Stream hold	✓	✓	✓	✓	✓	✓	✓	✓	✓	✓	✓	✓	✓	✓	✓
Temperature monitoring (main board only)	✓	✓	✓	✓	✓	✓	✓	✓	✓	✓	✓	✓	✓	✓	✓
User sets	✓	✓	✓	✓	✓	✓	✓	✓	✓	✓	✓	✓	✓	✓	✓

Table 39: Camera control feature availability by model



Some features are firmware dependent, refer to the GigE Firmware Release Notes for more information.

Mechanical dimensions

C-Mount (default)

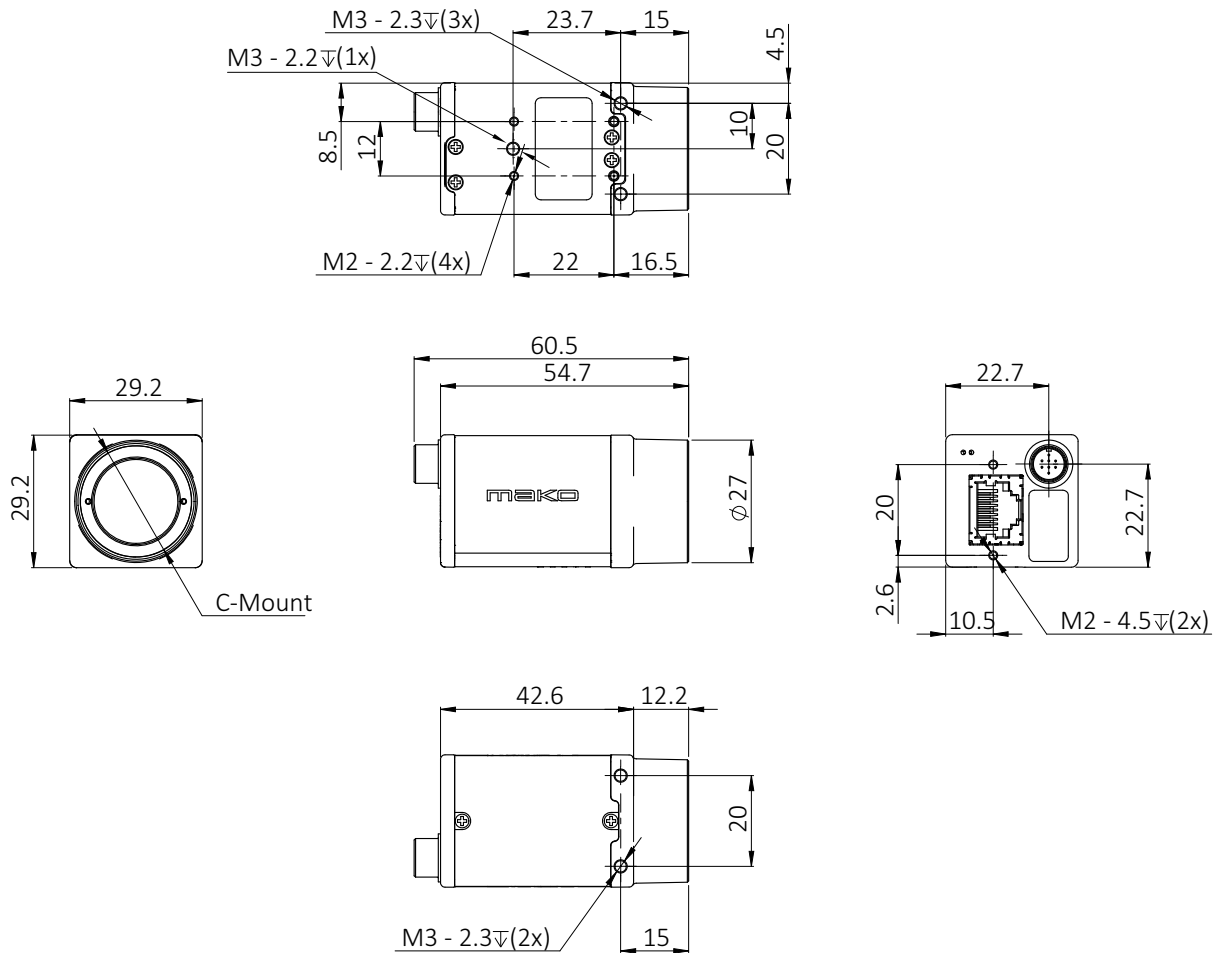

Figure 51: Mako with C-Mount dimensions (including connectors)

CS-Mount



Contact Allied Vision support for a technical drawing of the Mako with a CS-Mount. A STEP files is available on the technical documentation webpage.

M12-Mount (S-Mount)



Contact Allied Vision support for a technical drawing or STEP file of the Mako with a M12-Mount (S-Mount).

Tripod adapter

This tripod adapter (Allied Vision order number 4807) can be used for all Mako cameras with the standard housing.

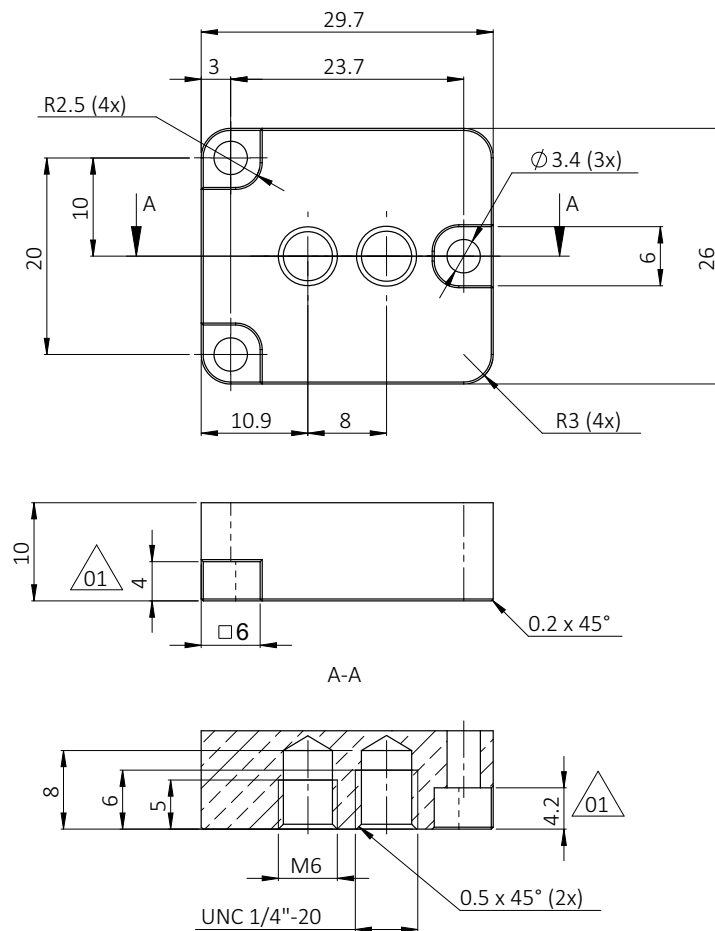

Figure 52: Tripod adapter dimensions (in mm)



NOTICE

Avoid damage to the camera by using inappropriate accessories
The Mako U tripod adapter is not compatible with Mako cameras.

Sensor position accuracy

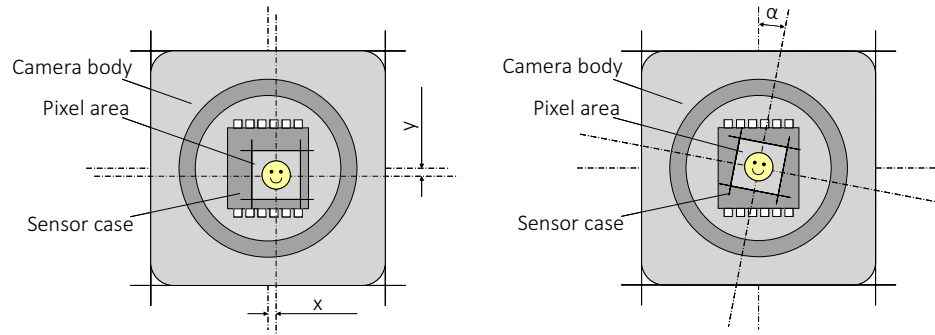

Figure 53: Sensor position accuracy

Unless stated otherwise, the following values are applicable:

Criteria	Subject	Properties
Alignment method		Optical alignment of photo sensitive sensor area into camera front module (lens mount front flange).
Reference points	Sensor	Center of pixel area (photo sensitive cells)
	Camera	Center of camera front flange (outer case edges)
Accuracy	x-axis y-axis	$\pm 150 \mu\text{m}$ (sensor shift)
	z	$0 \mu\text{m}$ to $-150 \mu\text{m}$ (optical back focal length)
	α	± 0.5 degrees (sensor rotation as the deviation from the parallel to the camera bottom)

Table 40: Sensor position accuracy criteria

Lens protrusion for different mounts

All standard color Mako cameras are equipped with a Type Hoya C-5000 IR cut filter with a 22 mm diameter. Standard monochrome and NIR Mako cameras are not equipped with any optical filter.

We offer several optical filter options for both monochrome, near infrared, and color Mako cameras. Choose an optical filter according to the Modular Concept.

C-Mount with 22 mm filter (default)

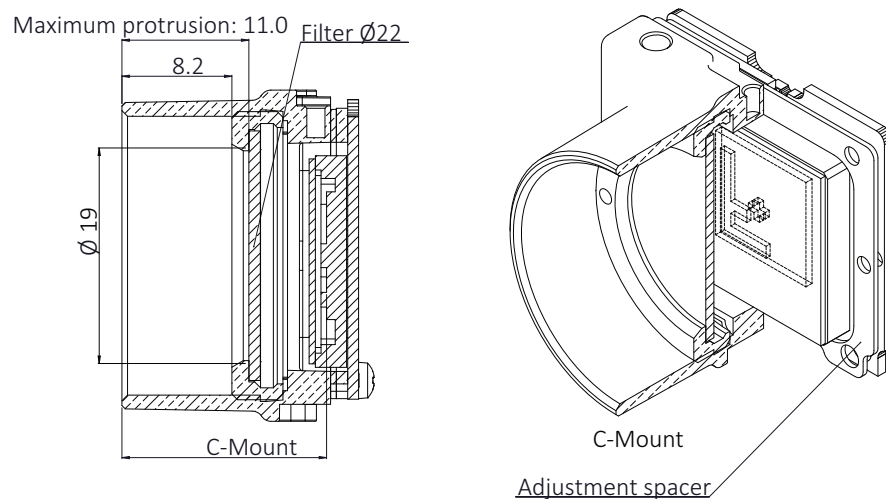

Figure 54: C-Mount with 22 mm filter



Monochrome Mako cameras with serial number 536873083 or higher are shipped without a cover ring in the C-Mount thread. Refer to product change notice for more details.

CS-Mount with 22 mm filter

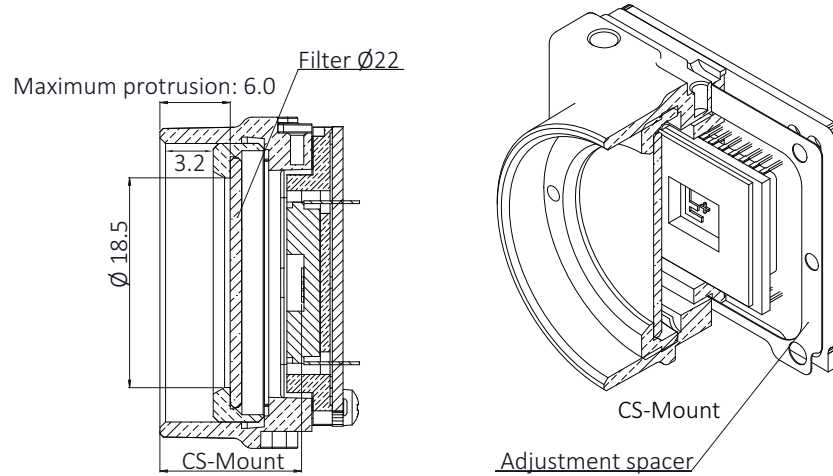

Figure 55: CS-Mount with 22 mm filter

M12-Mount (S-Mount) with 22 mm filter



Contact Allied Vision support for an cross section technical drawing of the Mako with a M12-Mount (S-Mount) and 22 mm filter.

C-Mount with 16 mm filter

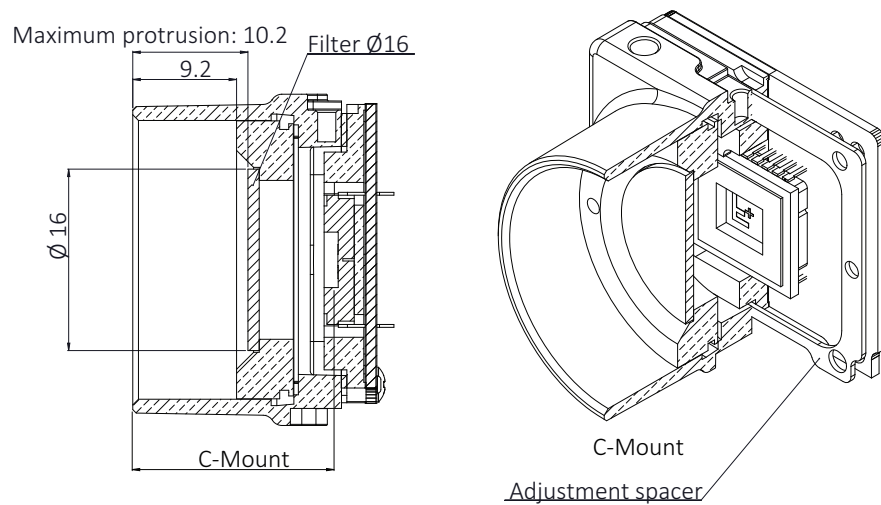

Figure 56: C-Mount with 16 mm filter

CS-Mount with 16 mm filter

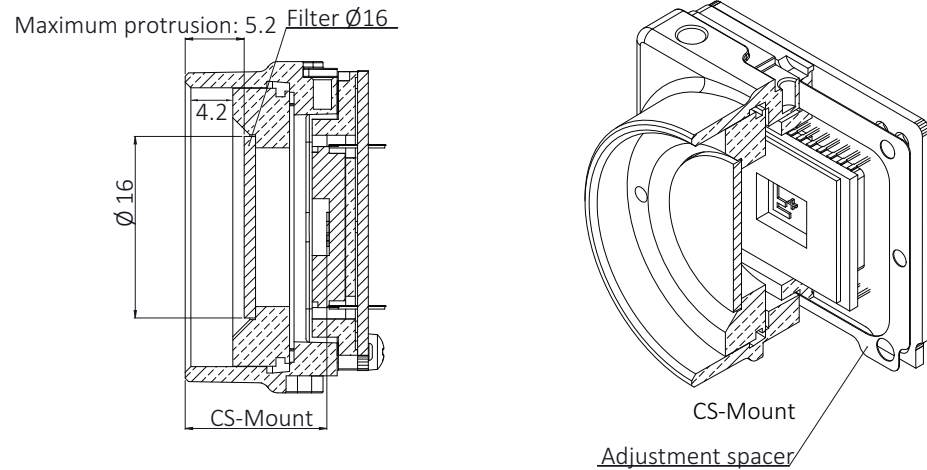

Figure 57: CS-Mount with 16 mm filter

M12-Mount (S-Mount) with 16 mm filter



Contact Allied Vision support for an cross section technical drawing of the Mako with an M12-Mount (S-Mount) and 16 mm filter.

Dimensional adjustment

The dimensional adjustment cannot be done by the customer. All modifications have to be done by Allied Vision. If you need any mount related adjustments, contact Allied Vision.

Filter and lenses



This chapter includes:

Focal length vs. field of view	115
Optical filters	123

Focal length vs. field of view

We offer different lenses from a variety of manufacturers. This section presents tables that list selected image field of view (width × height) depending on sensor size, distance and focal length of the lens.

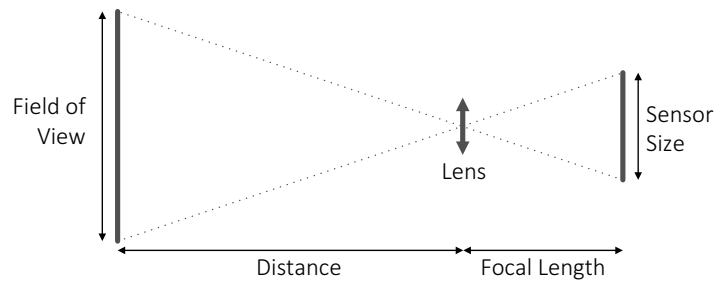

Lenses with focal lengths < 8 mm may show shading in the edges of the image due to microlenses on the sensor. The exact values vary and depend on the respective lens.

Mako G-032

The following table provides the field of view for various focal lengths. The values are valid for Mako G-032B and G-032C models.

Focal length	Field of view	
	Distance = 500 mm	Distance = 1000 mm
4.0 mm	608 × 446 mm	1220 × 896 mm
4.8 mm	506 × 371 mm	1016 × 746 mm
8 mm	301 × 221 mm	608 × 446 mm
12 mm	199 × 146 mm	403 × 296 mm
16 mm	148 × 109 mm	301 × 221 mm
25 mm	93 × 68 mm	191 × 140 mm
35 mm	65 × 48 mm	135 × 99 mm

Table 41: Mako G-032 focal length versus field of view

Mako G-040

The following table provides the field of view for various focal lengths. The values are valid for Mako G-040B and G-040C models.

Focal length	Field of view	
	Distance = 500 mm	Distance = 1000 mm
2.8 mm	888 × 666 mm	1781 × 1336 mm
4 mm	620 × 465 mm	1245 × 934 mm
4.2 mm	590 × 443 mm	1185 × 889 mm
4.8 mm	516 × 387 mm	1037 × 778 mm
6 mm	412 × 309 mm	828 × 621 mm
6.5 mm	380 × 285 mm	764 × 573 mm
8 mm	308 × 231 mm	620 × 465 mm
12 mm	203 × 153 mm	412 × 309 mm
16 mm	151 × 113 mm	308 × 231 mm
25 mm	95 × 71 mm	195 × 146 mm

Table 42: Mako G-040 focal length versus field of view

Mako G-131

The following table provides the field of view for various focal lengths. The values are valid for Mako G-131B and G-131C models.

Focal length	Field of view	
	Distance = 500 mm	Distance = 1000 mm
4.5 mm	760 × 606 mm	1526 × 1217 mm
6 mm	568 × 453 mm	1143 × 911 mm
10 mm	338 × 270 mm	683 × 545 mm
17 mm	196 × 156 mm	399 × 318 mm
25 mm	131 × 105 mm	269 × 215 mm
35 mm	92 × 73 mm	190 × 152 mm

Table 43: Mako G-131 focal length versus field of view

Mako G-158

The following table provides the field of view for various focal lengths. The values are valid for Mako G-158B and G-158C models.

Focal length	Field of view	
	Distance = 500 mm	Distance = 1000 mm
2.8 mm	888 × 666 mm	1781 × 1336 mm
4 mm	620 × 465 mm	1245 × 934 mm
4.2 mm	590 × 443 mm	1185 × 889 mm
4.8 mm	516 × 387 mm	1037 × 778 mm
6 mm	412 × 309 mm	828 × 621 mm
6.5 mm	380 × 285 mm	764 × 573 mm
8 mm	308 × 231 mm	620 × 465 mm
12 mm	203 × 153 mm	412 × 309 mm
16 mm	151 × 113 mm	308 × 231 mm
25 mm	95 × 71 mm	195 × 146 mm

Table 44: Mako G-158 focal length versus field of view

Mako G-192

The following table provides the field of view for various focal lengths. The values are valid for Mako G-192B and G-192C models.

Focal length	Field of view	
	Distance = 500 mm	Distance = 1000 mm
4.5 mm	793 × 595 mm	1593 × 1195 mm
6 mm	593 × 445 mm	1193 × 895 mm
10 mm	353 × 265 mm	713 × 535 mm
17 mm	205 × 153 mm	416 × 312 mm
25 mm	137 × 103 mm	281 × 211 mm
35 mm	96 × 72 mm	199 × 149 mm

Table 45: Mako G-192 focal length versus field of view

Mako G-223

The following table provides the field of view for various focal lengths. The values are valid for Mako G-223B and G-232C models.

Focal length ¹	Field of view	
	Distance = 500 mm	Distance = 1000 mm
4.8 mm	1162 × 617 mm	2335 × 1240 mm
6 mm	927 × 492 mm	1865 × 991 mm
6.5 mm	855 × 454 mm	1721 × 914 mm
8 mm	692 × 368 mm	1396 × 742 mm
10 mm	552 × 293 mm	1114 × 597 mm
12 mm	458 × 243 mm	927 × 492 mm
16 mm	341 × 181 mm	692 × 369 mm
25 mm	214 × 114 mm	439 × 223 mm
35 mm	150 × 79 mm	310 × 165 mm
50 mm	101 × 54 mm	214 × 114 mm
75 mm	64 × 34 mm	139 × 74 mm
90 mm	51 × 27 mm	114 × 60 mm

¹ A 2/3 inch lens may cause vignetting (1 inch lens recommended)

Table 46: Mako G-223 focal length versus field of view

Mako G-234

The following table provides the field of view for various focal lengths. The values are valid for Mako G-234B and G-234C models.

Focal length	Field of view	
	Distance = 500 mm	Distance = 1000 mm
12 mm	461 × 290 mm	933 × 586 mm
16 mm	343 × 215 mm	697 × 438 mm
25 mm	215 × 135 mm	442 × 278 mm
35 mm	150 × 94 mm	312 × 196 mm
50 mm	102 × 64 mm	215 × 135 mm

Table 47: Mako G-234 focal length versus field of view

Mako G-319

The following table provides the field of view for various focal lengths. The values are valid for Mako G-319B and G-319C models.

Focal length	Field of view	
	Distance = 500 mm	Distance = 1000 mm
5 mm	705 × 525 mm	1417 × 1055 mm
6 mm	586 × 436 mm	1180 × 878 mm
8 mm	438 × 326 mm	883 × 657 mm
10 mm	349 × 260 mm	705 × 525 mm
12 mm	290 × 216 mm	586 × 436 mm
16 mm	215 × 160 mm	438 × 326 mm
25 mm	135 × 101 mm	278 × 207 mm
35 mm	95 × 70 mm	196 × 146 mm
50 mm	64 × 48 mm	135 × 101 mm
75 mm	40 × 30 mm	88 × 65 mm

Table 48: Mako G-319 focal length versus field of view

Mako G-419

The following table provides the field of view for various focal lengths. The values are valid for Mako G-419B, G-419B NIR, and G-419C models.

Focal length	Field of view	
	Distance = 500 mm	Distance = 1000 mm
8 mm	692 × 692 mm	1396 × 1396 mm
10 mm	552 × 552 mm	1114 × 1114 mm
12 mm	458 × 458 mm	928 × 928 mm
16 mm	340 × 340 mm	692 × 692 mm
25 mm	214 × 214 mm	439 × 439 mm
35 mm	150 × 150 mm	310 × 310 mm
50 mm	101 × 101 mm	214 × 214 mm
75 mm	64 × 64 mm	139 × 139 mm
90 mm	51 × 51 mm	104 × 104 mm

Table 49: Mako G-419 focal length versus field of view

Mako G-507

The following table provides the field of view for various focal lengths. The values are valid for Mako G-507B and G-507C models.

Focal length	Field of view	
	Distance = 500 mm	Distance = 1000 mm
5 mm	842 × 703 mm	1692 × 1413 mm
8 mm	526 × 437 mm	1054 × 880 mm
10 mm	417 × 348 mm	842 × 703 mm
12 mm	346 × 289 mm	700 × 585 mm
16 mm	257 × 215 mm	523 × 437 mm
25 mm	162 × 135 mm	332 × 277 mm
35 mm	113 × 94 mm	234 × 196 mm
50 mm	77 × 64 mm	162 × 135 mm
75 mm	48 × 40 mm	105 × 88 mm

Figure 58: Mako G-507 focal length versus field of view

Mako G-508B POL

The following table provides the field of view for various focal lengths. The values are valid for Mako G-508B POL models.

Focal length	Field of view	
	Distance = 500 mm	Distance = 1000 mm
5 mm	842 × 703 mm	1692 × 1413 mm
8 mm	526 × 437 mm	1054 × 880 mm
10 mm	417 × 348 mm	842 × 703 mm
12 mm	346 × 289 mm	700 × 585 mm
16 mm	257 × 215 mm	523 × 437 mm
25 mm	162 × 135 mm	332 × 277 mm
35 mm	113 × 94 mm	234 × 196 mm
50 mm	77 × 64 mm	162 × 135 mm
75 mm	48 × 40 mm	105 × 88 mm

Figure 59: Mako G-508B POL focal length versus field of view

Mako G-511

The following table provides the field of view for various focal lengths. The values are valid for Mako G-511 models.

Focal length	Field of view	
	Distance = 500 mm	Distance = 1000 mm
5 mm	671 × 560 mm	1348 × 1125 mm
6 mm	558 × 466 mm	1122 × 937 mm
8 mm	417 × 348 mm	840 × 701 mm
12 mm	275 × 230 mm	558 × 466 mm
16 mm	205 × 171 mm	417 × 348 mm
25 mm	129 × 107 mm	264 × 221 mm
35 mm	90 × 75 mm	187 × 156 mm
50 mm	61 × 51 mm	129 × 107 mm

Table 50: Mako G-511 focal length versus field of view

Mako G-811

The following table provides the field of view for various focal lengths. The values are valid for Mako G-811 models.

Focal length [mm]	Field of view	
	Distance = 500 mm	Distance = 1000 mm
5 mm	773 × 773 mm	1553 × 1553 mm
6 mm	642 × 642 mm	1293 × 1293 mm
8 mm	480 × 480 mm	968 × 968 mm
12 mm	317 × 317 mm	642 × 642 mm
16 mm	236 × 236 mm	480 × 480 mm
25 mm	148 × 148 mm	304 × 304 mm
35 mm	104 × 104 mm	215 × 215 mm
50 mm	70 × 70 mm	148 × 148 mm

Table 51: Mako G-811 focal length versus field of view

Mako G-1242

The following table provides the field of view for various focal lengths. The values are valid for Mako G-1242 models.

Focal length [mm]	Field of view	
	Distance = 500 mm	Distance = 1000 mm
6 mm	931 × 679 mm	1874 × 1365 mm
8 mm	696 × 507 mm	1403 × 1022 mm
12 mm	460 × 335 mm	931 × 679 mm
16 mm	342 × 249 mm	696 × 507 mm
25 mm	215 × 157 mm	441 × 321 mm
35 mm	150 × 109 mm	312 × 227 mm
50 mm	102 × 74 mm	215 × 157 mm
75 mm	64 × 47 mm	139 × 102 mm

Table 52: Mako G-1242 focal length versus field of view

Optical filters

All color Mako cameras are equipped with a type Hoya C-5000 IR cut filter. This filter is employed to prevent infrared light from passing to the sensor. In the absence of an IR cut filter, images are dominated by red and incapable of being properly color balanced.

All monochrome and NIR Mako cameras do not employ an IR cut filter or protection glass.

The following plot shows the filter transmission response for the IR cut filter. Values may vary slightly by filter lot.

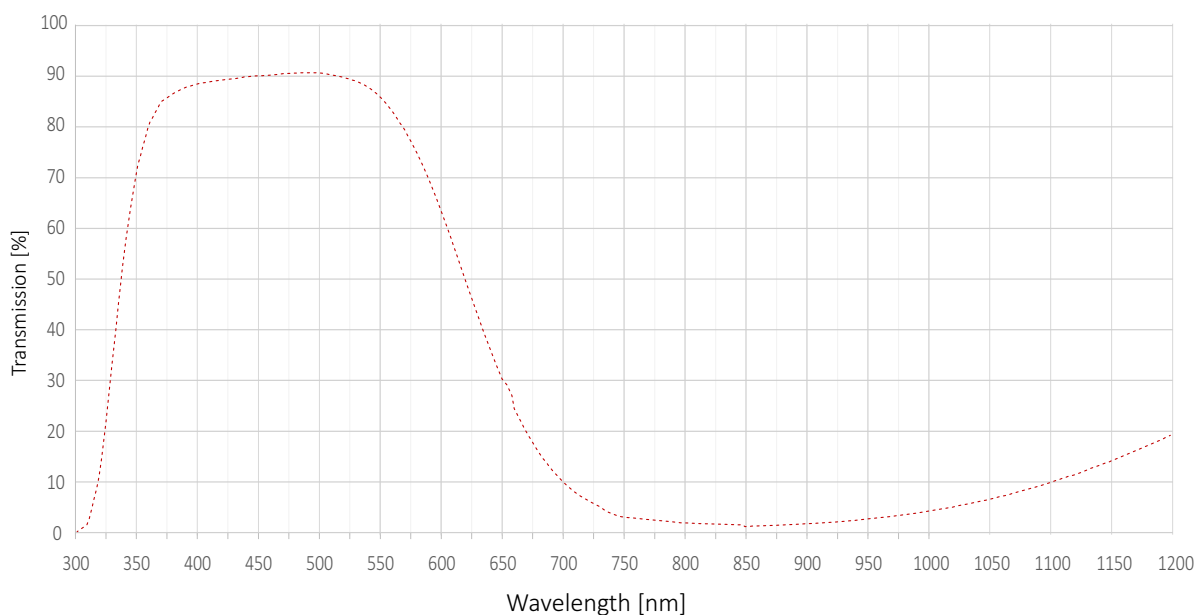

Figure 60: Optical filter spectral transmission (exemplary curve)

The Modular Concept informs about various options for optical filters and protection glass (ASG).



Modular Concept

See the Modular Concept for hardware options, including information on ordering at www.alliedvision.com/en/support/technical-documentation/mako-documentation.

Installing the camera



This chapter includes:

Touching hot cameras	125
Electrostatic discharge	125
Mounting the camera	126
Mounting the lens.....	128
Configuring the host computer	129
Connecting your camera.....	132
Powering up the camera.....	132
Connecting to host application.....	134
Accessories.....	135

Touching hot cameras



CAUTION

Risk of burns

A camera in operation can reach temperature levels which could cause burns.

- Wear protective gloves when you touch a camera that is heated up.
- Ensure proper cooling of the camera.

Electrostatic discharge



NOTICE

ESD is dangerous for electronic devices, especially when tools or hands get in contact with connectors. We recommend measures to avoid damage by ESD:

- Unpacking: Remove the camera from its anti-static packaging only when your body is grounded.
- Workplace: Use a static-safe workplace with static-dissipative mat and air ionization.
- Wrist strap: Wear a static-dissipative wrist strap to ground your body.
- Clothing: Wear ESD-protective clothing. Keep components away from your body and clothing. Even if you are wearing a wrist strap, your body is grounded but your clothes are not.

Mounting the camera



CAUTION

Injury by falling cameras or lenses

A falling camera or lens can cause injury.

- Ensure proper mounting of cameras and lenses, especially for dynamic applications.
- Mount cameras as described in the instructions.
- Always make sure the mounting threads are intact.
- Fasten screws with maximum torque, using the entire thread engagement. For less thread engagement, see [Adapting maximum torque values](#) on page 127.
- We recommend you to apply thread locking.
- Use a lens support for heavy lenses.

For technical drawings, see [Mechanical dimensions](#) on page 108.

Mounting, using the M3 threads

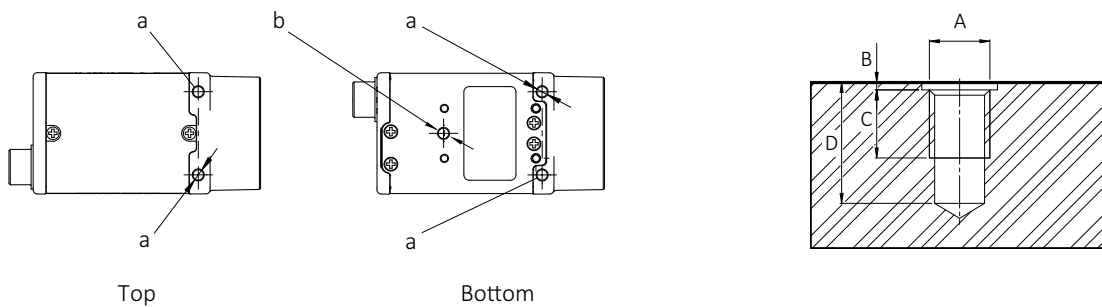

Detail a: Mounting thread M3 \downarrow 2.3 \downarrow 2.5
 A=M3 | B=0 | C=2.3 | D=2.5

Detail b: Mounting thread M3 \downarrow 2.2 \downarrow 2.4
 A=M3 | B=0 | C=2.2 | D=2.4

Figure 61: M3 top (a) and bottom and mounting threads (a and b)

The maximum torque value applies only if the entire thread engagement is used. For other values, see [Adapting maximum torque values](#) on page 127.

1. Mount the camera to the base using suitable M3 screws, see [Figure 61](#).

For **mounting holes a**: Use 0.53 Nm maximum torque for a thread engagement (C) of 2.3 mm between screws and mounting threads.

For **mounting hole b**: Use 0.51 Nm maximum torque for a thread engagement (C) of 2.2 mm between screws and mounting threads.

2. Continue with [Mounting the lens](#) on page 128.

Mounting, using the M2 threads

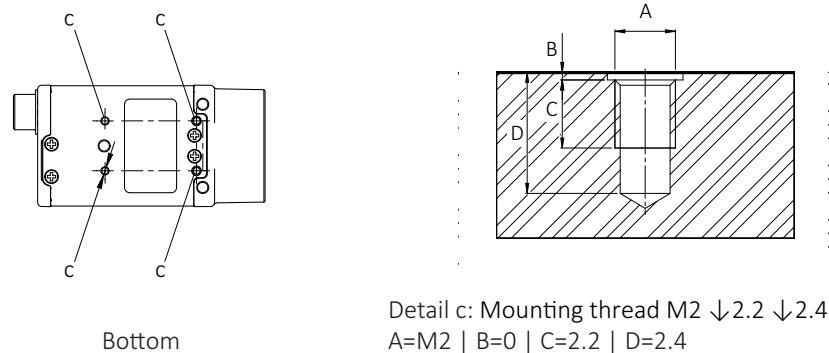

Figure 62: M2 bottom mounting threads (c)

The maximum torque value applies only if the entire thread engagement is used. For other values, see [Adapting maximum torque values](#) on page 127.

1. Mount the camera to the base using suitable M2 screws at 0.22 Nm maximum torque for a thread engagement (C) of 2.2 mm between screws and mounting threads, see [Figure 62](#).
2. Continue with [Mounting the lens](#) on page 128.

Adapting maximum torque values

This is a general example. Use the corresponding values for your camera. The total screw length composes of the mounting holes length and the height of your mounting base. For using less than the recommended length of thread engagement, calculate maximum torque as follows:

$$\frac{\text{Current length of thread engagement}}{\text{Length of thread engagement in table}} \times \text{Torque in table} = \text{Current torque}$$

Example for a length of thread engagement of **2.0 mm** instead of 2.2 mm:

$$\mathbf{2.0\ mm / 2.2\ mm \times 0.22\ Nm = 0.20\ Nm}$$

Thread group	Thread position	Thread type	Total protrusion	Length of thread engagement	Maximum torque
c	Bottom mounting	M2	2.4 mm	2.2 mm	0.22 Nm
c	Bottom mounting	M2	2.4 mm	2.0 mm	0.20 Nm

Table 53: Adjusting maximum torque values example

To ensure that the screws do not become loose over time, we recommend you to use means for securing screws, such as screw locking varnish.



Tripod adapter

For more information, see www.alliedvision.com/en/products/accessories/.

NOTICE

Avoid damage to the camera by using inappropriate accessories
The Mako U tripod adapter is not compatible with Mako cameras.

Mounting the lens

CAUTION
Injury by falling cameras or lenses

A falling camera or lens can cause injury.

- Ensure proper mounting of cameras and lenses, especially for dynamic applications.
- Mount cameras as described in the instructions.
- Use a lens support for heavy lenses.

CAUTION
Risk of cuts by sharp edges of lens mounts

The threads of the lens mount can have sharp edges.

Be careful when mounting or unmounting lenses.

NOTICE

As monochrome and NIR models don't have an optical filter, always attach a dust cap when a lens is not attached to minimize the possibility of contaminants falling on the sensor surface.

NOTICE

Provide the following conditions to keep dirt and droplets out of the optical system of camera and lens:

- Dust-free environment
- Low relative humidity
- No condensation

To keep dirt out of the lens mount, hold the camera with the lens mount facing the ground. Keep filter and camera back lens clean, because dirt becomes more visible the closer it gets to the sensor.

NOTICE

Image sensors are sensitive to excessive radiation: focused sunlight, lasers, and X-rays can damage the sensor.

**NOTICE**

Some cleaning agents can damage this product. Avoid cleaning the image sensor unless absolutely necessary. See the instructions on optics cleaning in this document.

We can clean your camera as a service for you, if necessary. For more information, contact Allied Vision support.

Mako cameras offer various lens mounts for installing a lens including C-Mount, CS-Mount, and M12-Mount (S-Mount). Lenses can be purchased directly from Allied Vision or from an Allied Vision distribution partner. Users need to select the desired focal length of the lens and appropriate optical format for the target camera model.

For more information on lens mount options for your Mako camera, see the Modular Concept. For information on available lenses and accessories for your camera, see the Accessories webpage.

Lens load

For non-static applications, use lenses with a mass less than 140 grams and a length less than 38 mm, where the center of gravity is 20 mm, measured from the lens mount front flange. For heavier or longer lenses, use a lens support and apply additional tests. For more information, please contact support at www.alliedvision.com/en/about-us/contact-us/technical-support-repair-/rma.

Configuring the host computer

Mako cameras can operate on 10/100 or Gigabit speed NICs. In order to reach the maximum camera frame rate, a Gigabit speed network NIC with jumbo packet support is required.

If your host computer has an available Ethernet port, this can be used with Mako cameras. We recommend that your camera system uses a dedicated Ethernet port not shared with Internet or local area networks. If more ports are needed, or your existing NIC is unable to operate at Gigabit Ethernet speeds, installing additional hardware may be required.

Usage on mixed-use networks (with printers, Internet and email) is possible but may impact camera performance (for example, frame rate). Check with your network administrator if required for network configuration.

Installing the NIC driver

Install the NIC driver from your network card manufacturer if available. If no installation application is provided, update the driver manually.

To update the driver manually

1. Click the **Start** icon and select **Control Panel** in the menu.
2. Click **View by Large icons** and select **Device Manager** in the list. A new window opens.
3. Under **Network Adapters**, locate the Ethernet network adapter, right-click the entry, and select **Update Driver Software** in the menu.
4. Select the **Search automatically for updated driver software or Browse my computer for driver software**.
5. Click **Close** after the driver has been installed.

IP settings

After the initial NIC hardware installation, connect the NIC directly to the camera. The default configuration assigns an IP address automatically using the LLA (Link-Local Address) range of 169.254.xxx.xxx or an address defined by the DHCP (Dynamic Host Configuration Protocol) server, if present. This setup is a typical solution for single-camera operation or multiple cameras connected to the same NIC.

If you are going to operate multiple cameras on different networks, you can use the following configuration as a template.

All network devices (such as NICs, hubs or GigE cameras) require unique IP addresses. But connected devices must share the same address space. In the example shown in [Table 54](#), 3 cameras are connected to a common host PC, using 2 separate NICs. The address space for NIC 1 is 192.168.**100**, for NIC 2 it is 192.168.**101**:

Device	IP address	Subnet mask	Default gateway
NIC 1	192.168.100.1	255.255.255.0	Blank
Camera 1 connected to NIC 1	192.168.100.2	255.255.255.0	Blank
NIC 2	192.168.101.1	255.255.255.0	Blank
Camera 2 connected to NIC 2	192.168.101.2	255.255.255.0	Blank
Camera 3 connected to NIC 2	192.168.101.3	255.255.255.0	Blank

Table 54: Static IP addresses for NICs and connected cameras

Optimize system performance

The NIC should be adjusted to improve system performance when using a Mako camera. This performance is related to minimizing CPU usage and dropped or resent packets.

Edit the NIC driver properties according to the values in the following table. The names and availability of the properties listed may vary depending on NIC manufacturer and model.

Property	Value
Packet size or maximum transmission unit	8228 bytes or larger
Interrupt moderation	Enable
Interrupt moderation rate	Extreme
Receive buffers	Maximum value configurable
Transmit buffers	256 bytes

Table 55: NIC settings

Default packet size

The default packet size of Mako cameras is 8228 bytes. The host NIC needs to support a packet size of equal or larger size to stream from the camera.

NIC settings

The NIC settings may also vary depending on your system configuration and the NIC manufacturer.

For desktop systems, use a PCI Express bus NIC. For laptops, use an expansion slot via an ExpressCard.

A list of recommended NICs is available on the Allied Vision website. See the Hardware Selection for Allied Vision GigE Cameras application note.

Enabling jumbo packets

The properties listed for the NIC may include either **Jumbo Packet** or **Jumbo Frames** depending on the manufacturer. If neither is listed under properties, your NIC may not support this feature. You must use a NIC that supports Jumbo Frames or Jumbo Packets.

To enable jumbo packets

1. Click the **Start** icon and select **Control Panel** in the menu.
2. Click **View by Large icons** and select **Device Manager** in the list.

3. Under **Network Adapters**, locate the Ethernet network card, right-click the entry, and select **Properties** in the menu.
4. Select the **Advanced** tab.
5. Select the property **Jumbo Packet** and set the value to **9014 Bytes**.
6. Click **OK** to save the setting.

Connecting your camera

Use a Category 6 or higher rated Ethernet cable to connect the Mako camera to the NIC. Crossover cabling is not required but does work. The camera has circuitry to determine if a crossover cable is being used.



We recommend Category 6 (CAT6) or higher rated Ethernet cables for Mako cameras. A different rating may not sustain peak interface bandwidth; leading to lost connectivity or dropped frames coming from the camera.

Powering up the camera

A camera power adapter for Mako cameras is available from Allied Vision. See the Specifications chapter for connector definition and voltage specifications.



A 12 V power adapter with Hirose connector is available for purchase from Allied Vision:

- Order code: 13868 (Desktop power supply without connection cable)
- Order code: 13866 (AC power cable, 1.8 m, US to C13)
- Order code: 13865 (AC power cable, 1.8 m, EU to C13)



NOTICE

- Use only DC power supplies with insulated cases.
- For all power connections, use only shielded cables to avoid electromagnetic interference.
- Mako cameras can source power from:
 - IEEE 802.3af (100 Mbps and 1000 Mbps), and
 - IEEE 802.3at Type 1 compliant PoE power sourcing equipment devices such as switches, injectors, or NIC.



NOTICE

Don't operate the camera beyond the environmental specifications. See the environmental specifications limits in the Specifications section of this document. Special care must be taken to maintain operating temperature as specified in the Specifications chapter.

**NOTICE**

Avoid damage to the camera from high output current or voltage:

- Connecting the camera to a device exceeding the allowed maximum current (20 mA per output) can damage the camera.
- Providing Isolated Out Power > 30 Volts may damage the camera.

**NOTICE**

Verify all external connections in terms of voltage levels, power requirements, voltage polarity, and signal integrity prior to powering the device.

**NOTICE**

Operation outside the allowed temperature range can damage the camera. For best performance and to protect the camera from damage, keep the housing temperature in the specified operating temperature range. Housing temperature of the camera increases during power-up and initial operation. This temperature later stabilizes.

Observe the following:

- For maximum heat dissipation, affix the camera to a heat sink, using the mounting threads.
 - Use mounting base and heat sink with large surface areas.
 - Use a mounting base with a high thermal conductivity.
- Reduce ambient temperature. For example, in an outdoor application with direct sunlight, provide shading by an enclosure.
- Provide ventilation or other active cooling of camera, mounting base, and heat sink.



The camera is not intended to be connected to a DC distribution network. The maximum length for I/O cables must not exceed 30 meters.

Powering the camera via Hirose I/O port

Cameras powered by both the Hirose I/O port and the Gigabit Ethernet port use the power provided by Hirose I/O port only.

Powering the camera via PoE

Please note the following when using PoE accessories with Allied Vision PoE-capable GigE cameras:

- Mako cameras conform to the IEEE 802.3at Type 1 standard for GigE.

- Ensure that your Power Sourcing Equipment (PSE) provides data over all four pairs.
- If the PSE uses only two out of four pairs for data, operation is limited to 100 Mbps. This translates to lower frame rates.
- If the PSE uses all four pairs for data, operation is in Gigabit (1000 Mbps) mode. Thus, allowing you to achieve the maximum possible frame rate.

Connecting to host application

After you have installed the **Vimba Viewer** or third-party application to your host computer, connect your Mako camera via an Ethernet cable. If your camera is not PoE powered, connect the Hirose cable to power the camera.

Allied Vision software

Software packages provided by Allied Vision are free of charge and contain such as:

- Drivers
- SDK for camera control and image acquisition
- Examples based on the provided APIs of the SDK
- Documentation and release notes
- Viewer application to operate and configure the cameras

Vimba is Allied Vision's GenICam-based SDK with transport layers for all Allied Vision cameras with GigE Vision, USB3 Vision, IEEE 1394, and Camera Link interface. Vimba runs on Windows, Linux, and Linux for ARM. You can port your source code from Windows to Linux or cross-compile from a Linux PC to an embedded system.

Vimba provides APIs for C, C++, and .NET. Users who quickly want to develop a straightforward application love the simplicity of the C API or the .NET API.

Advanced users with high demands appreciate the C++ API, which is designed as a highly efficient and sophisticated API for advanced object-oriented programming including the STL (standard template library), shared pointers, and interface classes.

Vimba includes programming examples in C, C++, and C# and an extensive user documentation.



Download Vimba SDK from www.alliedvision.com/en/products/software. After installing, documentation is located under `\Program Files\Allied Vision\Vimba`.

Third-party software

In addition to the software provided by Allied Vision, there are numerous GigE Vision standard compliant third-party software options available. In general, third-party software provides increased functionality such as image processing and video recording.

GenICam-based third-party software automatically connects with Vimba's transport layers. Additionally, Vimba includes the Cognex Adapter for VisionPro.

Configuring your camera

After the host PC is configured, it is necessary to configure the parameters in the camera to establish the connection with best performance. It is necessary to note the value for the feature `GevSCPSPacketSize` which defines the size of the network packets and also the size of the feature `StreamBytesPerSecond` which controls the available bandwidth of the network interface.

If just one camera is connected, the maximum value can be used and therefore set to 124,000,000. When using multiple cameras simultaneously on one network adapter through a switch, we recommend to divide the available amount of `StreamBytesPerSecond` by the number of connected cameras. When two cameras with the same parameter share the available bandwidth, the usable maximum value for each camera is 62,000,000.

Accessories

We offer a wide range of accessories for use with Mako cameras including:

- Gigabit Ethernet accessories, such as standard GigE components or PoE capable GigE components.
- Lenses for corresponding sensor sizes and resolutions.

For information on available lenses for your camera, see the Accessories webpage.



A list of recommended GigE components is available on the Allied Vision website. See the Hardware Selection for Allied Vision GigE Cameras application note at www.alliedvision.com/en/support/faqs-application-notes.

Camera interfaces

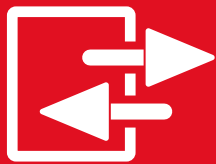

This chapter includes:

Back panel	137
Status LEDs	137
Gigabit Ethernet port	138
Camera I/O connections	138
Control signals	143
Camera trigger	145

Back panel

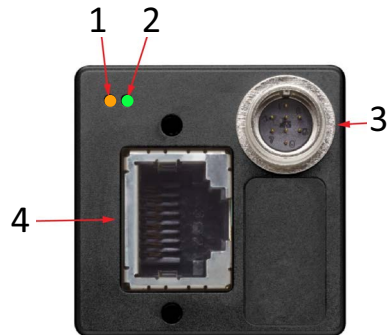

Figure 63: Rear view of Mako cameras

1	LED 1 (orange)
2	LED 2 (green)
3	Hirose I/O port
4	Gigabit Ethernet port

Table 56: Ports and LEDs

Status LEDs

The following tables describe the Mako status LEDs.

LED 1	Status
Solid orange	Ethernet link established
Flashing orange	Network traffic

Table 57: Status LED 1

LED 2	Status
Solid green	Camera booted correctly
Fast flashing green	Booting routine
Slow flashing green	Transmission error Please contact support at www.alliedvision.com/en/about-us/contact-us/technical-support-repair-/rma .

Table 58: Status LED 2

Gigabit Ethernet port

The Gigabit Ethernet port conforms to the IEEE 802.3 1000BASE-T standard for Gigabit Ethernet over copper. To prevent EMI and for best performance, Category 6 (or higher) cables with S/STP shielding and connectors are recommended. Applications with longer cable lengths or harsh EMI conditions require Category 7 (or higher) cables.



- Cable lengths up to 100 meters are supported.
- The 8-pin RJ-45 jack provides a pin assignment according to the Ethernet standard, IEEE 802.3 1000BASE-T.
- All Mako cameras are PoE capable (IEEE 802.3at Type 1).
- If both the Hirose I/O port and Gigabit Ethernet port (via PoE) are used for power, the camera only uses the power from the Hirose I/O port.

Camera I/O connections

The general purpose I/O port uses a Hirose HR25-7TR-8PA(73) connector on the camera side. The mating cable connector is Hirose HR25-7TP-8S.



A 12 V power adapter with Hirose connector is available for purchase from Allied Vision:

- Order code: 13868 (Desktop power supply without connection cable)
- Order code: 13866 (AC power cable, 1.8 m, US to C13)
- Order code: 13865 (AC power cable, 1.8 m, EU to C13)



The camera is not intended to be connected to a DC distribution network. The maximum length for I/O cables must not exceed 30 meters.



Safety-related instructions to avoid malfunctions

Read all Notes and Cautions in the Hardware and Installation chapter before using the Hirose I/O connector.



Hirose connector

The cable side Hirose connector is available for purchase from Allied Vision (order code K7600503).

I/O connector pin assignment

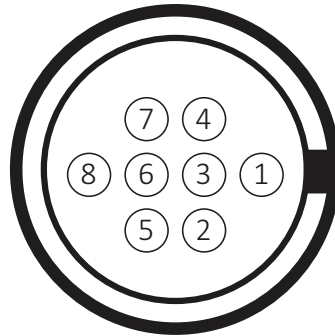

Camera side Hirose HR25-7TR-8PA(73) connector					I/O cable color code
Pin	Signal	Direction	Level	Description	
1	Out 1	Out	Open emitter, maximum 20 mA	Opto-isolated output 1	Yellow dot Red
2	Out 2	Out	Open emitter, maximum 20 mA	Opto-isolated output 2	Yellow dot Black
3	Out 3	Out	Open emitter, maximum 20 mA	Opto-isolated output 3	Gray dot Red
4	In 1	In	$U_{in}(\text{high}) = 3.0 \text{ to } 24.0 \text{ V}$ up to 36 V with external resistor of 3.3 k Ω in series $U_{in}(\text{low}) = 0 \text{ to } 1.0 \text{ V}$	Opto-isolated input 1	Gray dot Black
5	Isolated In GND	In	---	Isolated input signal ground	Pink dot Black
6	Isolated Out Power	In	Common VCC for outputs maximum 30 VDC	Power input for opto- isolated outputs	Pink dot Red
7	Camera Power	In	12 to 24 VDC $\pm 10\%$	Camera power supply	Orange dot Black
8	Camera GND	In	Ground for external power	Ground for camera power supply	Orange dot Red

Table 59: Camera I/O connector pin assignment and I/O cable color coding



For cable color and pin out information, see the Allied Vision I/O cable overview:
www.alliedvision.com/fileadmin/content/documents/products/accessories/cable/datasheet/IO-Cable_Overview_DataSheet.pdf.

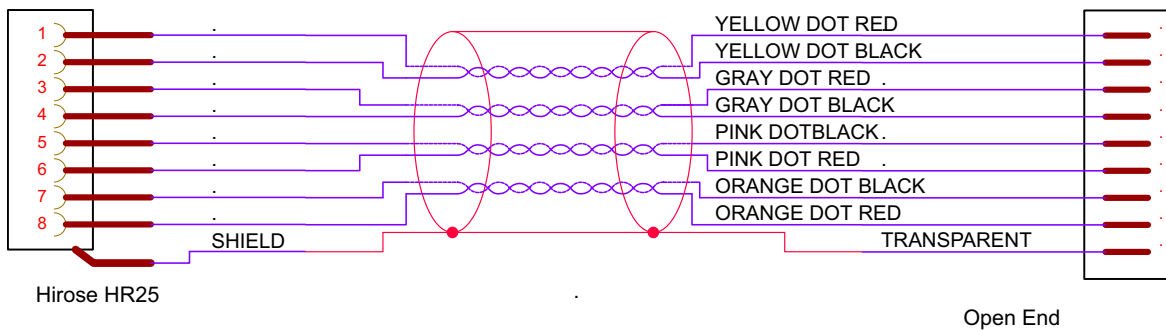

Figure 64: Mako cable color coding

Input block diagram

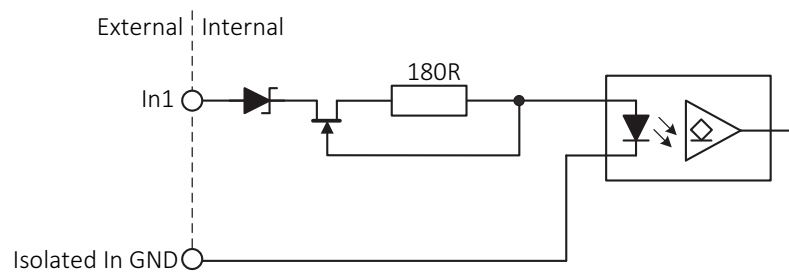

Figure 65: Input block diagram

The input can be connected directly to the system for voltages up to 24 VDC. An external resistor is not necessary.

Input parameters

Parameter	Value
U_{in} (low)	0 to 1.0 V
U_{in} (high)	3 to 24 V
Current (constant-current source)	3 to 4 mA

Table 60: Input parameters

Minimum pulse width

The minimum pulse width for all Mako cameras is:

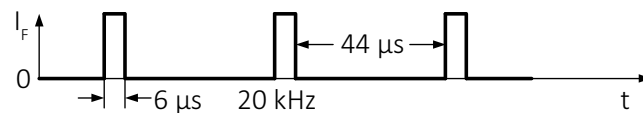

Figure 66: Minimum pulse width

Test conditions

The input signal was driven with 3.3 Volts and no external additional series resistor.

Output block diagram

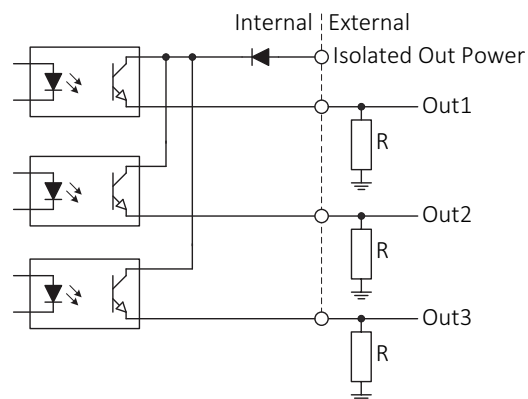

Figure 67: Output block diagram

NOTICE

Output and isolated out power:

- Maximum 20 mA per output
- Isolated out power > 30 V may damage the camera

Isolated Out Power	Resistor value ¹	
5 V	1.0 kΩ	at ~ 5 mA minimum required current draw
12 V	2.4 kΩ	
24 V	4.7 kΩ	

¹ Resistor required if Out1, Out2, Out3 connected to a device with < 5 mA draw, that is, high impedance

Table 61: Isolated Out Power and external resistor

Output switching times

Optocoupler input (internal)

Optocoupler output (external)

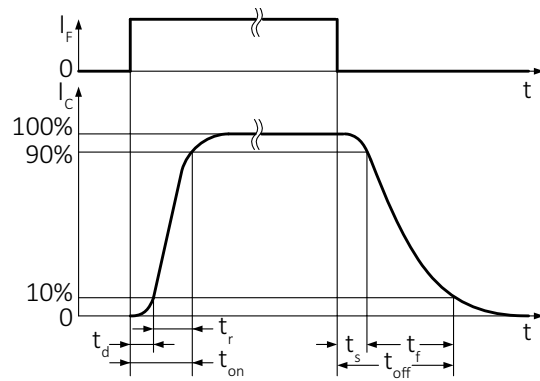

t_d delay time t_s storage time
 t_r rise time t_f fall time
 $t_{on} (= t_d + t_r)$ turn-on time $t_{off} (= t_s + t_f)$ turn-off time

Figure 68: Output switching times

Parameter and value	
$t_d \approx 1 \mu\text{s}$	$t_s \approx 26 \mu\text{s}$
$t_r \approx 1 \mu\text{s}$	$t_f \approx 21 \mu\text{s}$
$t_{on} = t_d + t_r \approx 2 \mu\text{s}$	$t_{off} = t_s + t_f \approx 47 \mu\text{s}$ (t_{off} can deviate by $\pm 5 \mu\text{s}$)

Table 62: Parameters

Test conditions

Output: external 2.4 k Ω resistor to ground, Isolated Out Power set to 12 Volts.



- Higher external values increase the times.
- It is recommended to trigger on the rising edge. This guarantees the fastest possible reaction time.

Control signals

The inputs and outputs of the camera can be configured by software. The different modes are described in this section. All input and output signals that pass the I/O connector are controlled by the I/O strobe commands.

Input block diagram

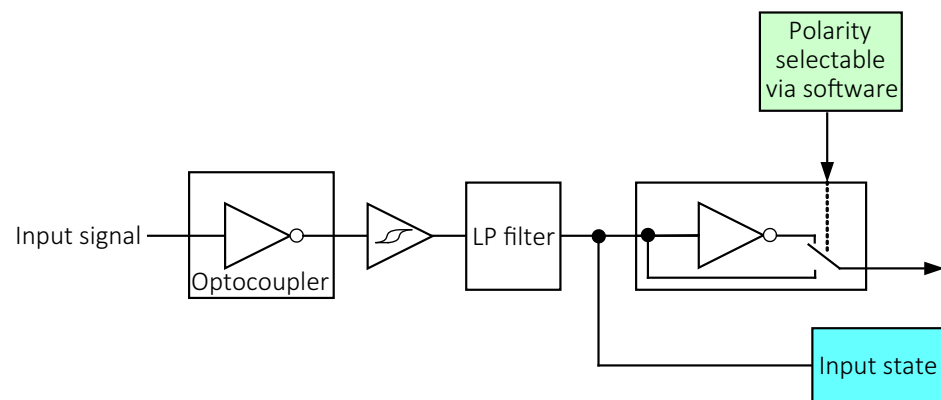

Figure 69: Input block diagram

Output signals

Output signals are configured by software. Any signal can be placed on any output. The main output signals are described in the following table.

Signal	Description
GPO	Configured to be a general purpose output, control is assigned to <code>SyncOutGpoLevels</code> .
AcquisitionTriggerReady	Active after the camera has been recognized by the host computer and is ready to start acquisition.
FrameTriggerReady	Active when the camera is in a state that accepts the next frame trigger.
FrameTrigger	Active when an image has been initiated to start. This is a logic trigger internal to the camera, which is initiated by an external trigger or software trigger event.
Exposing	Active for the duration of sensor exposure.
FrameReadout	Active during frame readout, that is, the transferring of image data from the sensor to the camera memory.
Imaging	Imaging is high when the camera image sensor is either exposing or reading out data.
Acquiring	Active during an acquisition stream.
SyncIn1	Active when there is an external trigger at <code>SyncIn1</code> .
Strobe1	The output signal is controlled according to <code>Strobe1</code> settings.

Table 63: Output signals

Output block diagram

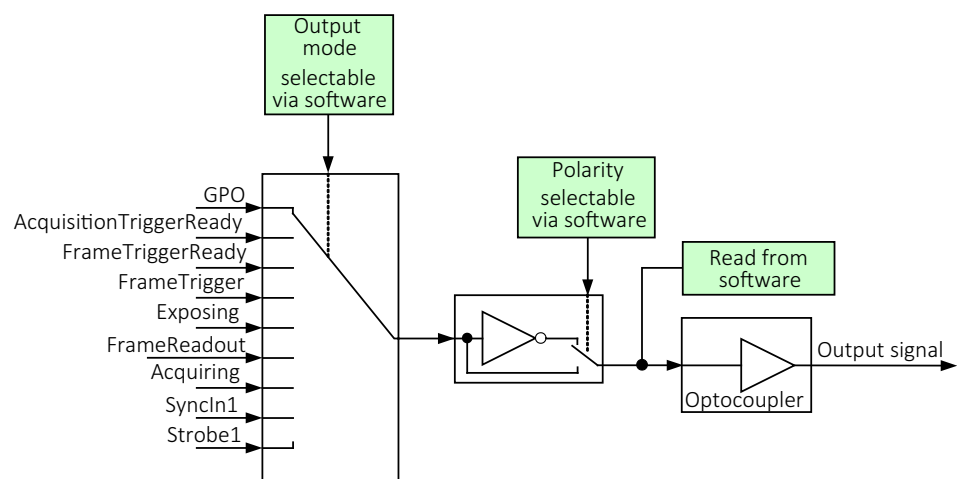

Figure 70: Output block diagram

Camera trigger

For trigger description on camera control basis, see the GigE Features Reference.

Trigger timing diagram

The following diagram explains the general trigger concept for CCD-sensor models.

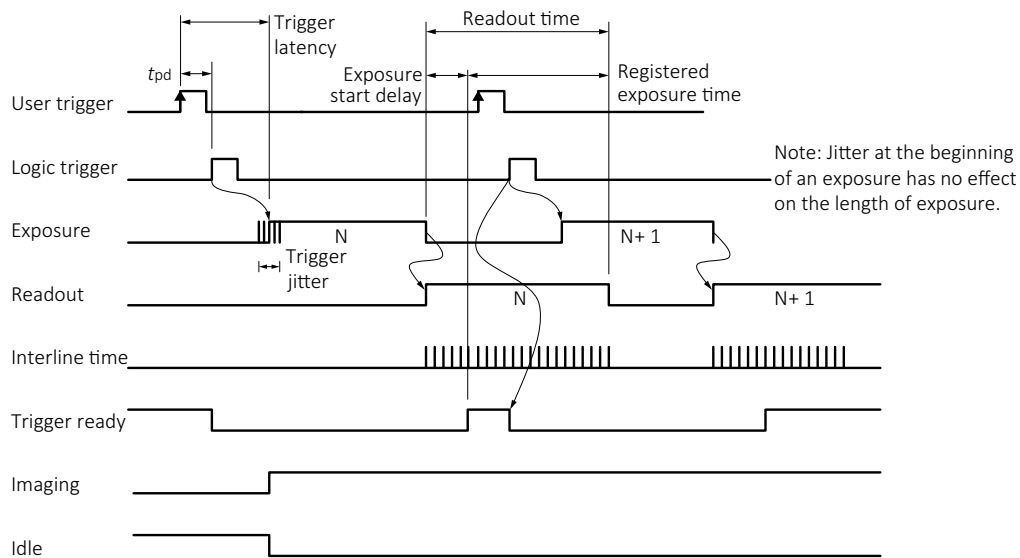

Figure 71: Internal signal timing waveforms (CCD-sensor models)

The following diagram explains the general trigger concept for CMOS-sensor models.

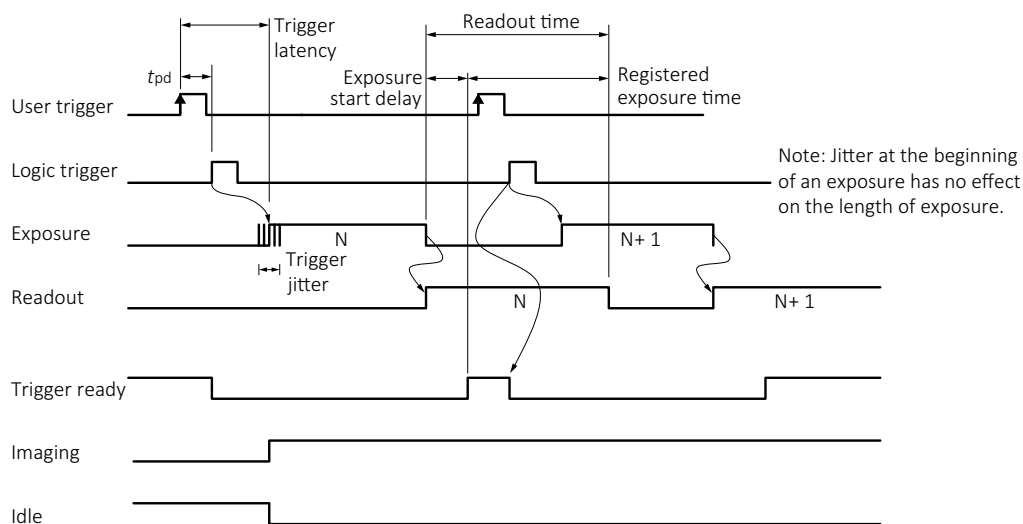

Figure 72: Internal signal timing waveforms (CMOS-sensor models)

Trigger definitions

Term	Definition
User trigger	Trigger signal applied by the user (hardware trigger, software trigger)
Logic trigger	Trigger signal seen by the camera internal logic (not visible to the user)
Propagation delay (t_{pd})	Propagation delay between the user trigger and the logic trigger
Exposure	High when the camera image sensor is integrating light
Readout	High when the camera image sensor is reading out data
Trigger latency	Time delay between user trigger and start of exposure
Trigger jitter	Error in the trigger latency time
Trigger ready	Indicates that the camera can accept the next trigger
Registered exposure time	Exposure time value currently stored in the camera memory
Exposure start delay	Registered exposure time subtracted from the readout time and indicates when the next exposure cycle can begin such that the exposure ends after the current readout
Interline time	Time between sensor row readout cycles (CCD models only)
Imaging	High when the camera image sensor is either exposing or reading out data
Idle	High if the camera image sensor is not exposing or reading out data

Table 64: Trigger definitions

Trigger rules



Overlapping exposure and readout (Mako G-131 and G-192)

The Teledyne e2v sensor does not support overlapped exposure and readout in hardware trigger mode or in global reset mode.

- The user trigger pulse width should be at least 6 μ s.
- The end of exposure always triggers the next readout.
- The end of exposure must always end after the current readout.
- The start of exposure must always correspond with the interline time if readout is true.
- Exposure start delay equals the readout time minus the registered exposure time.

Triggering during the idle state

For applications requiring the shortest possible trigger latency and the smallest possible trigger jitter, the user trigger signal should be applied when imaging is false and idle is true.

Triggering during the readout state

For applications requiring the fastest triggering cycle time whereby the camera image sensor is exposing and reading out simultaneously, the user trigger signal should be applied as soon as a valid trigger ready is detected.

In this case, trigger latency and trigger jitter can be up to one line time since exposure must always begin on an Interline boundary.



For a more detailed description of the trigger concept for advanced users and special scenarios, see the Triggering Concept application note at www.alliedvision.com/en/support/faqs-application-notes.

Image data flow

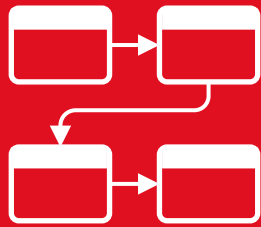

This chapter includes:

Mako models with CCD sensors.....	149
Mako models with CMOS sensors	150
Color interpolation (Bayer demosaicing).....	153

A complete listing of camera features, including definitions can be found on the Allied Vision Technical Documentation webpage.

- Vimba and third-party users: GigE Features Reference
- PvAPI users: GigE Camera and Driver Attributes document

Mako models with CCD sensors

Mako G-032 and G-125

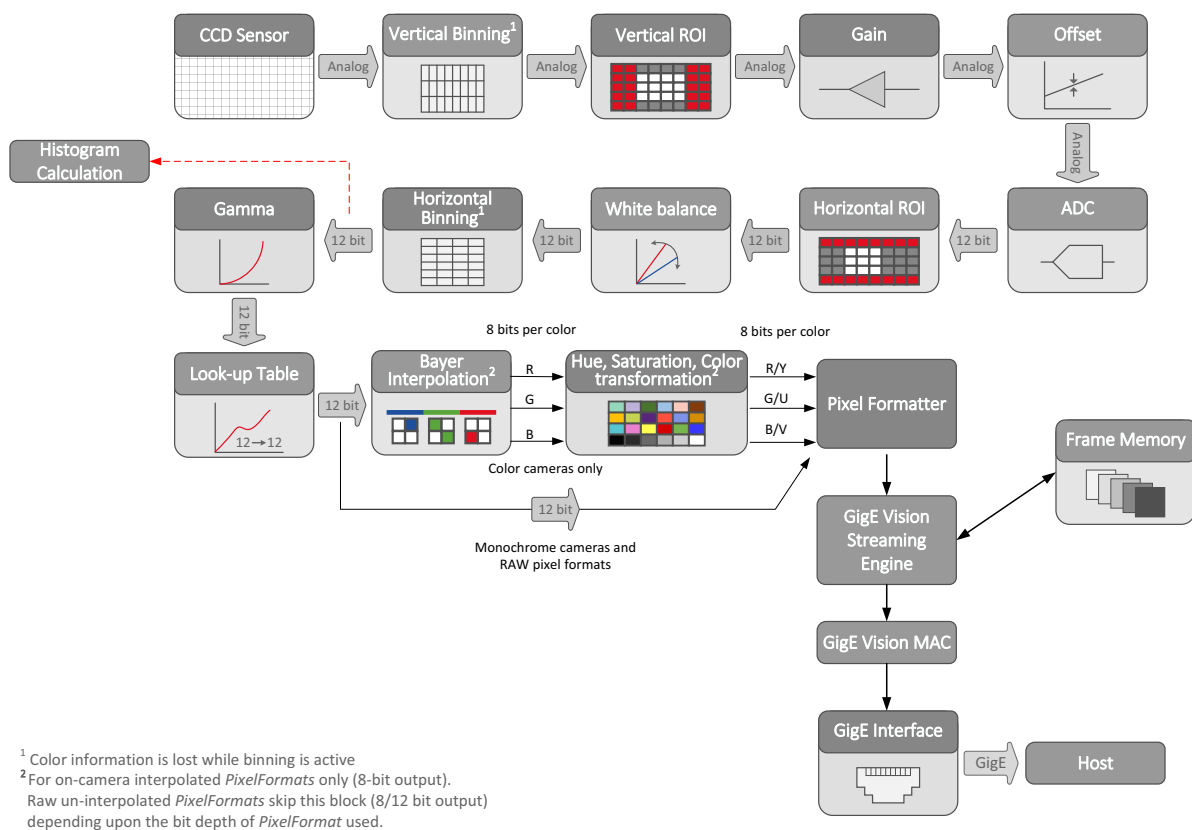

Figure 73: Mako G-032 and G-125 image data flow

Mako models with CMOS sensors

Mako G-131 and G-192

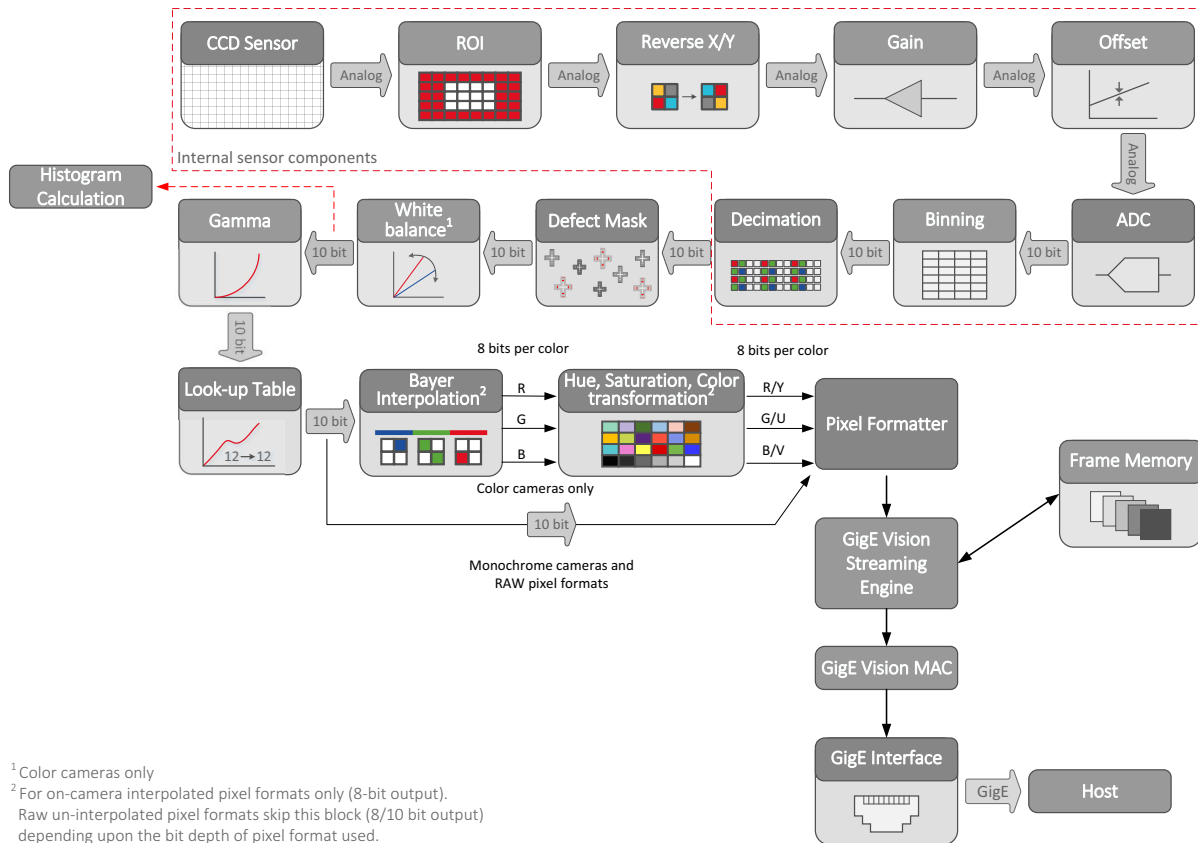

Figure 74: Mako G-131 and G-192 image data flow

Mako G-223 and G-419

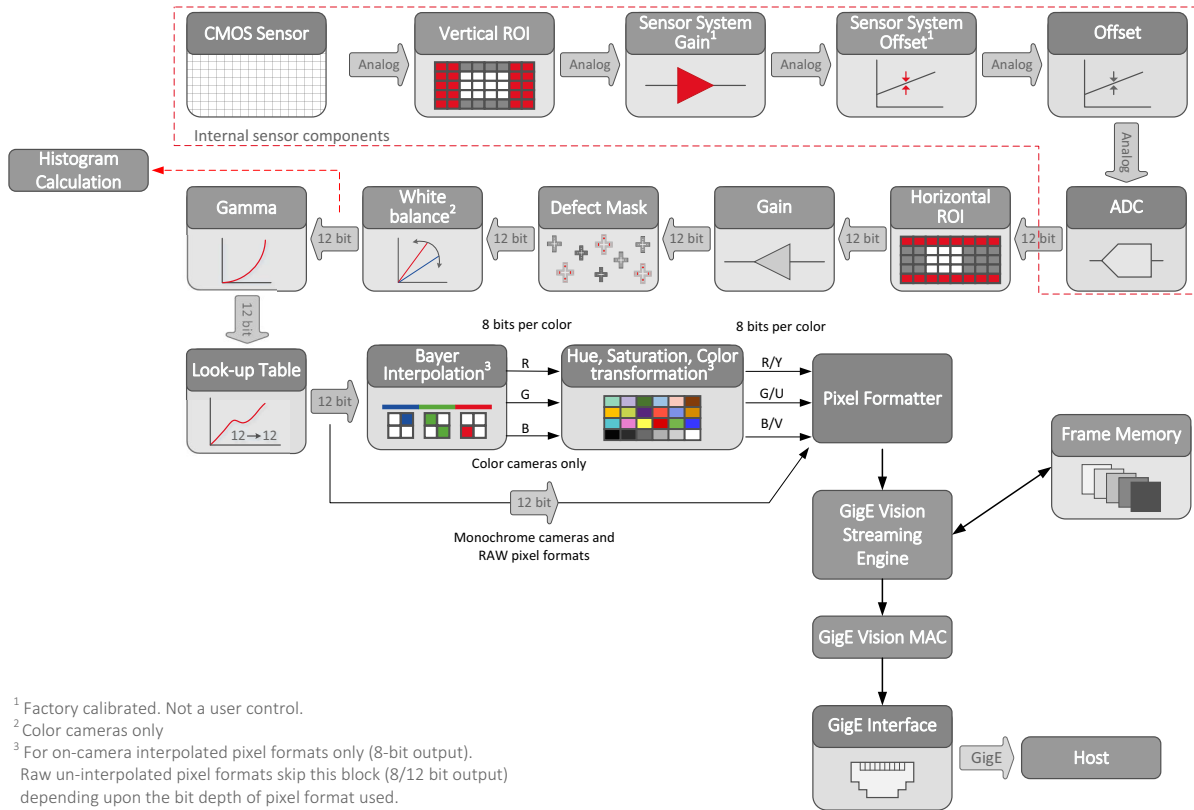

Figure 75: Mako G-223 and G-419 image data flow

Mako G-040, G-158, G-234, G-319, G-507, G-508B POL, G-511, G-811, and G-1242

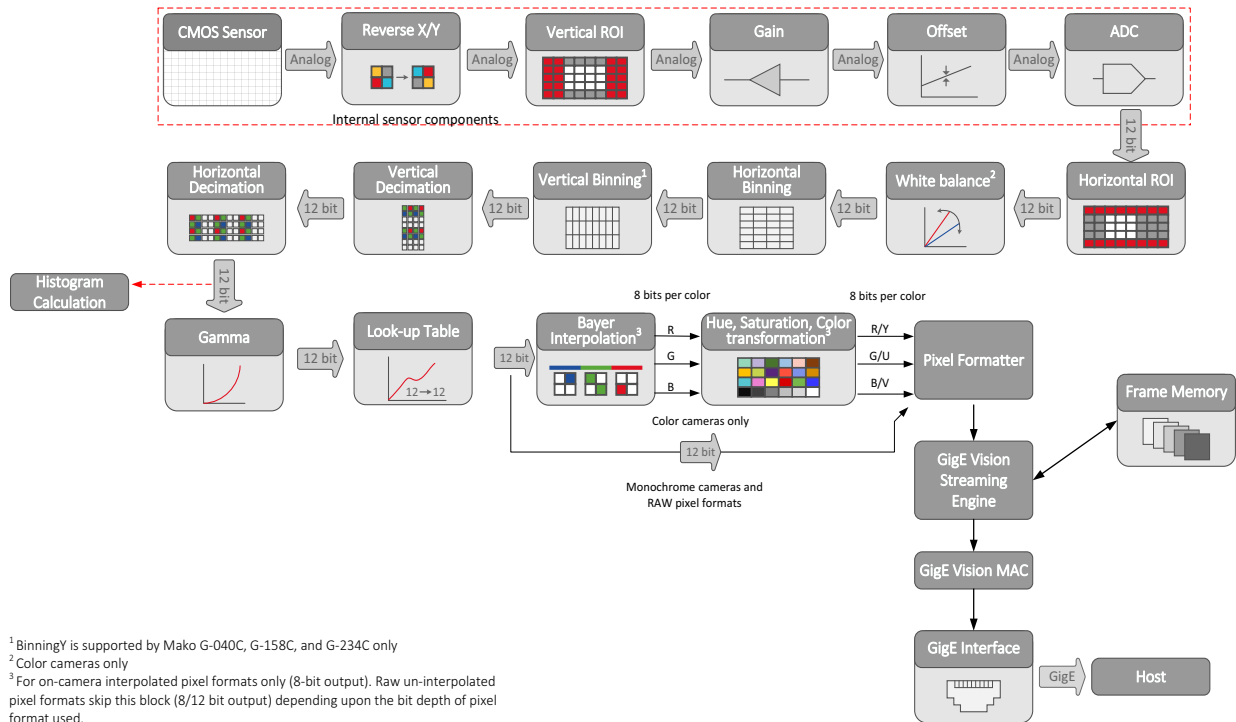

Figure 76: Mako G-040, G-158, G-234, G-319, G-507, G-508B POL, G-511, G-811, and G-1242 image data flow



Mako G-234B, G-234C supports 10-bit and 12-bit sensor readout mode. 10-bit data is processed as 12-bit data with 2 LSB bits padded with zeros.

Color interpolation (Bayer demosaicing)

The color sensors capture the color information via so-called primary color (R-G-B) filters placed over the individual pixels in a Bayer mosaic layout. An effective Bayer to RGB color interpolation already takes place in all Mako color version cameras.

In color interpolation a red, green, or blue value is determined for each pixel. A proprietary Bayer demosaicing algorithm is used for this interpolation, optimized for both sharpness of contours as well as reduction of false edge coloring.

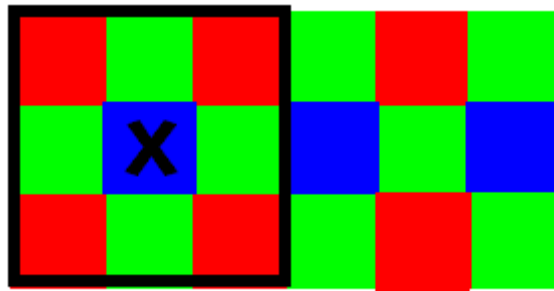

Figure 77: Bayer demosaicing (example of 3×3 matrix)

Color processing can be bypassed by using the RAW image transfer.

RAW mode is primarily used to:

- save bandwidths on the Gigabit Ethernet network
- achieve higher frame rates
- use different Bayer demosaicing algorithms on the host computer
 - for Mako, the first pixel of the sensor is red



When the host computer does not perform Bayer to RGB post-processing, the monochrome image is superimposed with a checkerboard pattern.

In color interpolation a red, green, or blue value is determined for each pixel (P1= first pixel; P2= second pixel). Only two lines are needed for this interpolation:

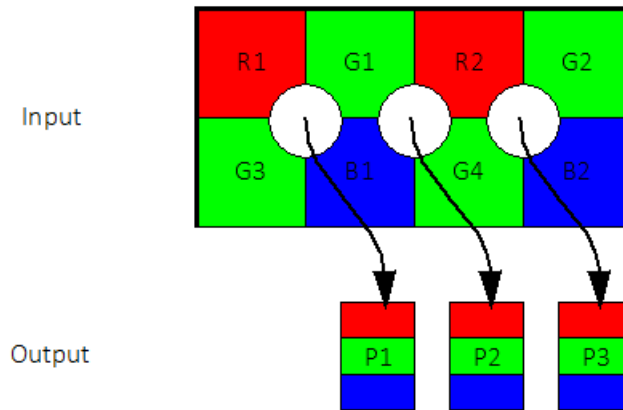

Figure 78: Bayer demosaicing (interpolation)

$$\begin{array}{lll}
 P1_{\text{red}} = R1 & P2_{\text{red}} = R2 & P3_{\text{red}} = R2 \\
 P1_{\text{green}} = \frac{G1 + G3}{2} & P2_{\text{green}} = \frac{G1 + G4}{2} & P3_{\text{green}} = \frac{G2 + G4}{2} \\
 P1_{\text{blue}} = B1 & P2_{\text{blue}} = B1 & P3_{\text{blue}} = B2
 \end{array}$$

Figure 79: Bayer demosaicing



- Note that on the color camera, an incorrectly colored border of one or two pixel wide forms on the left and right image borders. This is also a consequence of Bayer demosaicing as the image width displayed on the color camera is not scaled down.
- Using a ROI, **x** and **y** resolutions must be even-numbered.

Cleaning optical components



This chapter includes:

Keeping optical components clean.....	156
Identifying impurities.....	157
Locating impurities.....	157
Materials for cleaning optical components.....	159
Cleaning Instructions	160



Read these instructions before you contact Allied Vision or your Allied Vision distribution partner for assistance.

Contact Allied Vision or your Allied Vision distribution partner if you are not familiar with the procedures described in this chapter.



NOTICE

As monochrome and NIR models do not have an optical filter, always attach a dust cap when a lens is not attached to minimize the possibility of contaminants falling on the sensor surface.

Keeping optical components clean

The best way to ensure the camera remains clean is to avoid penetration of foreign substances into the camera.

When screwing or unscrewing the camera lens or dust cap, hold the camera with the lens mount opening towards the floor. This minimizes the possibility of any contaminants falling on the glass surface. Always store cameras and lenses with dust-caps on.



Figure 80: Illustration of camera orientation when removing lens or dust cap

Identifying impurities

If you observe any image artifacts in your video preview of your Mako camera you may have impurities either on the lens, optical filter, or on the sensor surface. Every Mako camera is cleaned prior to sealing and shipment; however, impurities may develop due to handling or unclean environments.

As shown in the following figure, impurities (dust, particles, or fluids) on the sensor or optical components appear as a dark area, patch or spot on the image and remain fixed in the preview window while you rotate the camera over the target.

Don't confuse this with a pixel defect which appears as a distinct point. Particles can either rest loosely or can be more or less stuck to the optical surface.

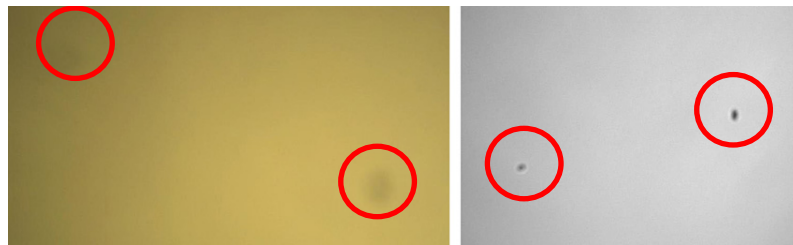

Figure 81: Image with tiny dust on the filter (left) and dust on the sensor (right)

Locating impurities

Before dismounting the lens, find out if the impurity is on the filter, lens, or sensor:

1. Start acquiring a uniform image (for example a white sheet of paper).
2. To identify the affected surface, move the suspected optical component and see if the contamination follows this movement.
 - a. If you move only the lens (not the camera) and the impurity moves as well, the impurity is on the lens.
 - b. If you move the optical filter window and the impurity moves as well, the impurity is on the optical filter. Carefully remove the optical filter and clean it on both sides using the techniques explained in the next section.



3. If the impurity is neither on the lens nor the optical filter, it is probably on the sensor.

Removing the IR cut filter

Standard Mako G-507C models with SN \geq 536883430 and all other standard Mako models with SN \geq 536884750 are equipped with a 22 mm diameter IR cut filter. Filters can be removed with the E9020001 filter removal tool.

For other Mako cameras, see the following table.

Model	Serial number	Filter glass diameter	Removal tool	Pin distance
Mako G-507C	\geq 536883430	22 mm	E9020001	21 mm
	$<$ 536883430	16 mm	E9020001	21 mm
	$<$ 536883430	22 mm	3851	22 mm
Other models	\geq 536884750	22 mm	E9020001	21 mm
	$<$ 536884750	16 mm	E9020001	21 mm
	$<$ 536884750	22 mm	3851	22 mm

Table 65: Filter removal tools for Mako cameras

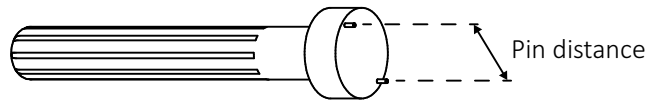

Figure 82: Pin distance for E9020001 filter removal tool

Materials for cleaning optical components



Use only these cleaning materials for optical components

- Optic approved lens cotton, cloth, or tissue that is chemically pure and free from silicones and other additives.
- Optic approved low residue cleaning liquid.



NOTICE

Never use these cleaning materials for optical components:

- Dry swabs or tissue may cause scratches.
- Metal tools may cause scratches.
- Disposable cotton cosmetic swabs may contain contaminants harmful to optical glass.
- Cosmetic cotton may cause scratches or get caught in small gaps.
- Consumer eyeglass cleaning cloths may be pretreated with silicone harmful to optical glass.
- Aggressive cleaners like benzene, acetone, or spirits may damage the surface.



Optical cleaning liquid material safety data sheets

Read the MSDS for the optical cleaning liquid before cleaning your camera or optics. The MSDS provides important information including hazard identification, first aid measures, handling and storage, and PPE.

Cleaning Instructions



Workplace conditions:

- Perform all cleaning operations (lenses, optical filter, and sensor) in a dust-free clean-room.
- Avoid touching the optical components with your fingers or any hard material.
- Nitrile cleanroom gloves or powder free latex gloves are recommended to maintain low particulate levels.
- Use an ESD mat to prevent damage from an electrostatic discharge.

1. Unplug the camera from any power supply before cleaning.
2. Apply a small amount of cleaning liquid to a new lens cleaning cotton, cloth, or tissue. The cotton, cloth, or lens tissue should be moist, but not dripping.



3. Hold the camera sensor diagonally upwards. Ensure that the camera is away from your body to prevent particles like skin flakes from falling on the sensor.
4. Wipe the glass surface with a spiral motion from the center to the rim. Normally, several spiral wipes are recommended. Wipe only on glass avoiding contact to metal surfaces, because microscopic dirt could be released and could cause scratches on the glass.
5. When you have finished cleaning, examine the surface in a strong light. Take an out-of-focus picture of a flat, illuminated surface to see if any dirt or dust remains.
6. If dust spots remain, repeat this procedure using new clean lens tissue (as previously described).



If you notice that the camera lens or sensor is not clean after attempting to clean twice, or if you have any questions regarding cleaning your camera, contact your Allied Vision distribution partner.

Cleaning with compressed air

We do not recommend cleaning Mako cameras with compressed air.

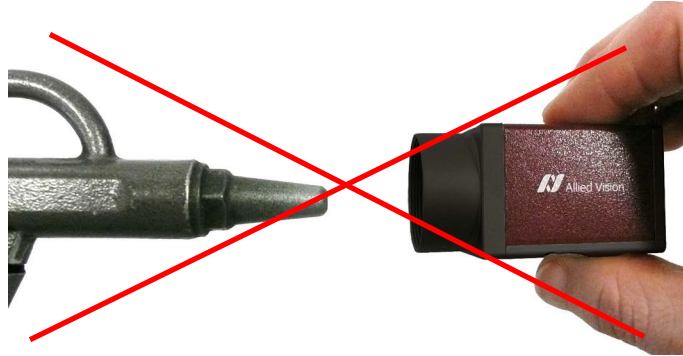

Figure 83: Cleaning with compressed air is not recommended



NOTICE

Possible material damage

- Compressed air at high pressure or shorter operating distances may push dust into the camera or lens and physically damage the camera, sensor, or optical components.
- Propellant from non-optic approved compressed air products may leave a residue on the camera or lens and may physically damage the camera, sensor, or optical components.
- Compressed air may contain oil or moisture that could contaminate or damage the optical components.
- Use an air blower or compressed air only if you are familiar with cleaning a camera using this method.

If you want to clean your camera with compressed air despite of all the warnings:

- Use an optic approved compressed air product or compressor.
- Use an anti-static ionizer attachment to reduce the risk of static-caused damage.
- Use a filter to remove moisture and oil from the air.
- Use short directed bursts of air to remove impurities.



Compressed air pressure and operating distance

- Keep the compressed air pressure at a moderate strength only. Pressure at the nozzle should be less than 100 kPa.
- Operating distance from the camera should be 5 to 30 cm.

Firmware update



This chapter includes instruction on how to update the firmware on your Mako camera.



If new firmware contains a new feature or control, saved camera UserSets or ConfigFiles are invalidated and erased!

Before loading new firmware, backup your current camera settings.

- **Vimba Viewer:** select the **Save Camera Settings** icon from the **Cameras** window to export the camera settings file (XML) to the host computer.
- **GigE SampleViewer:** select the **Disk** icon from the **Cameras** window to export camera settings file (XML) to the host computer.



NOTICE

Do not unplug the GigE cable or camera power supply during the update procedure.

Updating the firmware on your Mako camera

1. Launch the **Firmware Loader**.

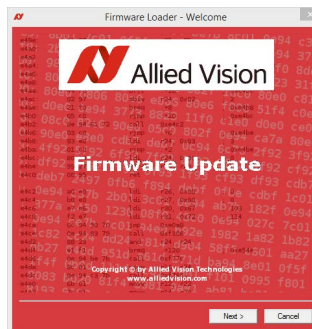

2. Click **Next**. The **Firmware Loader** displays a list of firmware included in the package

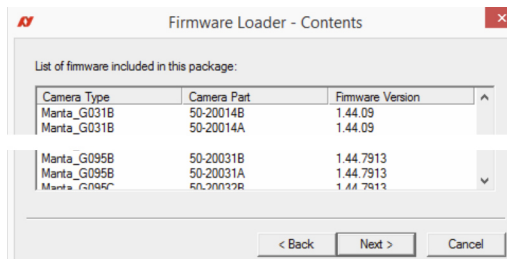

3. Click **Next**. You can select your camera model on this page.

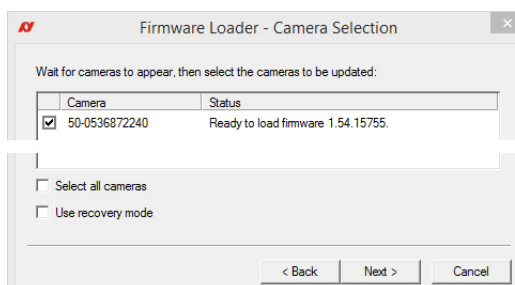



Select the **Use recovery mode** check box if the connected GigE camera is not found by the firmware loader, or if the GigE camera is listed as unavailable. When selected, power cycle the camera to enter the **Boot Loader** mode.

4. Click **Next**.

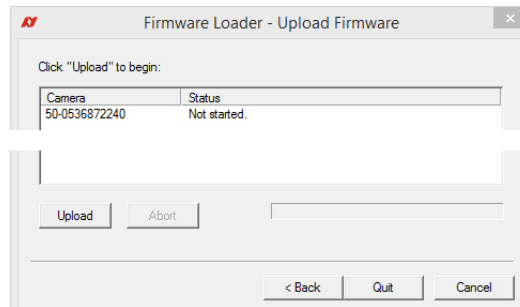

5. Click **Upload** to start the update. The existing firmware is erased and the new firmware is uploaded to the camera.

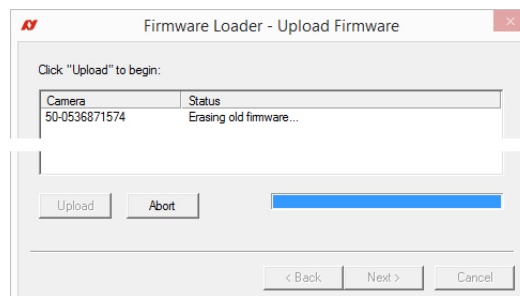

6. The **Firmware Loader** completion. Click **Quit** to exit the loader.

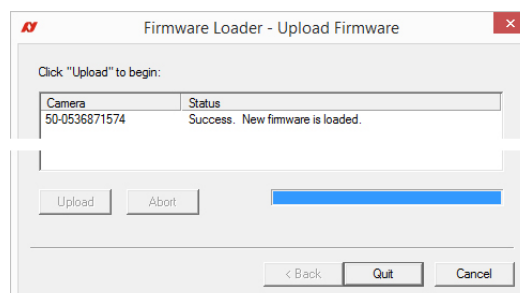

Always power cycle the camera after a firmware upgrade or downgrade.

Index

A		G	
Acquisition stream	144	General purpose output	144
B		General safety notes	37
Back panel	137	GenICam	43
Bandwidth		Gigabit Ethernet	
RAW-mode	153	Cable type	138
BAYER mosaic	153	IEEE 802.3 1000BASE-T	138
BAYER to RGB		GigE Vision	43
Color interpretation	153	GPO	144
C		H	
Camera lenses	115	heat dissipation	38
Category 6	132	I	
Cleaning		I/O	
Compressed air	161	Connector pin assignment	138
Instructions	160	Control signals	143
Locating impurities	157	IEEE 802.3af-2003	138
Materials	159	Input block diagram	143
Color interpolation		Interline boundary	147
Color information	153	Interpolation	
Compliance		BAYER demosaicing	154
USA	35	BAYER to RGB	153
Control signals		Isolated out power	142
Input block diagram	143	L	
Copyright	37	lenses	
Cross section		maximum protrusion	41
C-Mount	111	Logic trigger	144
CS-Mount	111	M	
D		Manual conventions	
Dimensional mount adjustment	113	Styles	30
Dimensions	44	Symbols	31
Duration of sensor exposure	144	Mass	44
E		Minimum pulse width	141
electrostatic discharge	31	O	
Environmental specifications	132	Output	
ESD	31, 40	block diagram	141
External trigger	144	switching times	142
F		Output current	133
Feature comparison	106	Output signal	144
Focal length	115	Acquiring	144
Frame memory	44	AcquisitionTriggerReady	144
Frame readout	144	Exposing	144
Frame trigger	144	FrameReadout	144
		FrameTrigger	144
		FrameTriggerReady	144

Imaging	144	Status LEDs.	137
Strobe1	144	SyncIn1	
SyncIn1.	144	External trigger	144
SyncOutGpoLevels	144		
Output switching		T	
parameters	142	Trigger	
		Definitions	146
P		Exposure	146
PoE		Exposure start delay	146
IEEE 802.3af-2003	138	Idle	146
Power		Imaging	146
DC	132	Interline time	146
		Logic trigger	146
R		Propagation delay	146
RAW mode	153	Readout	146
ROI measurements	44	Registered exposure time	146
		Rules	146
S		Time delay	146
safety	2, 4, 8, 14, 31	Timing diagram	145
camera power	40	Tpd	146
electrical connections	40	Trigger jitter	146
heat dissipation	38	Trigger latency	146
lens mounts	38	Trigger ready	146
maximum protrusion	41	User trigger	146
optical components	41	Tripod adapter	109
sensor	41		
sensor handling	41	V	
Sensor position accuracy	110	Voltage	133
Sensor row readout cycles	146		
Specifications	43		