

Alvium

1800 U-030 VSWIR

- IMX991 VSWIR sensor
- ALVIUM image processing
- USB3 Vision interface
- Various hardware options

Hardware option: Closed Housing C-Mount Standard

Alvium 1800 U – Your entry into high-performance imaging

Industrial USB cameras with attractive price-performance ratio

Alvium 1800 U-030 VSWIR with Sony IMX991 | InGaAs runs 249.0 frames per second at 0.3 MP resolution.

Alvium 1800 U is your entry into high-performance imaging with ALVIUM® Technology for industrial applications. Equipped with the newest generation of sensors, these small and lightweight cameras deliver high image quality and frame rates at the best price-performance ratio. With its USB3 Vision compliant interface and industrial-grade hardware, it is your workhorse for different machine vision applications whether it is on a PC-based or an embedded system.

Easy software integration with **Vimba X** and compatibility to the most popular third party image-processing libraries.

In addition to lens mount and housing options, see [Customization and OEM Solutions webpage](#) for additional options.

Specifications

Product code	15961
Interface	USB3 Vision
Resolution	656 (H) × 520 (V)
Spectral range	400 nm to 1700 nm
Sensor	Sony IMX991 InGaAs
Sensor type	InGaAs
Shutter mode	GS (Global shutter)
Sensor size	Type 1/4 VSWIR
Pixel size	5 μm × 5 μm
Lens mount	C-Mount
Max. frame rate at full resolution	249 fps at ≥200 MByte/s, Mono8
ADC	12 Bit
Image buffer (RAM)	256 KByte
Non-volatile memory (Flash)	1024 KByte

Output

Bit depth	8-bit, 10-bit, 12-bit; Adaptive (10-bit, 12-bit)
Monochrome pixel formats	Mono8 (default), Mono10, Mono10p, Mono12, Mono12p

General purpose inputs/outputs (GPIOs)

TTL I/Os	4 programmable GPIOs
----------	----------------------

Operating conditions/dimensions

Operating temperature	-20 °C to +65 °C (housing)
Power requirements (DC)	Power over USB 3.1 Gen 1 External power 5.0 V
Power consumption	USB power: 2.0 W (typical) Ext. power: 2.2 W (typical)
Mass	65 g
Body dimensions (L × W × H in mm)	38 × 29 × 29

Quantum efficiency



Features

Image control: Auto

- Auto exposure
- Auto gain

Image control: Other

- Adaptive noise correction
- Binning
- Black level
- Contrast
- Custom convolution
- DPC (defect pixel correction)
- Gamma
- LUT (look-up table)
- Reverse X/Y
- ROI (region of interest)
- Sharpness/Blur

Camera control

- Acquisition frame rate
- Bandwidth control
- Counters and timers
- Firmware update in the field
- I/O and trigger control
- Readout modes (SensorBitDepth)
- Sequencer
- Serial I/Os
- Temperature monitoring
- U3 Power Saving Mode
- User sets

Technical drawing

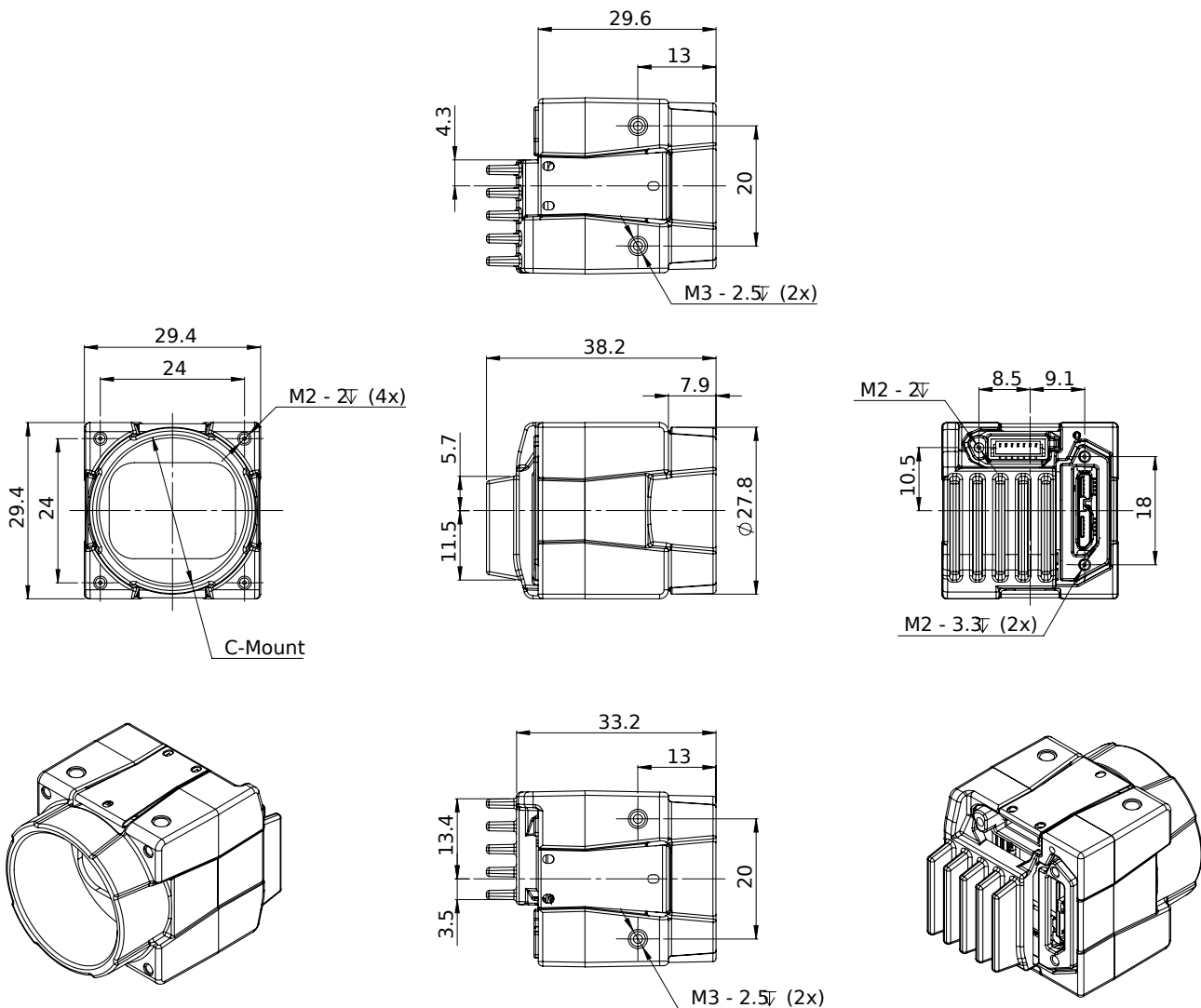

Applications

Alvium 1800 U-030 VSWIR cameras are sensitive in the visible and the SWIR spectrum and are well-suited for many typical SWIR applications in various industry branches:

- Semiconductor industry: Solar cell and chip inspection
- Recycling industry: Plastic sorting
- Medical imaging, sciences: Hyper- and multi-spectral imaging
- Glass industry: Defect detection through hot glass
- Agriculture industry: Airborne remote sensing
- Printing industry: Seeing hidden features
- Surveillance: Vision enhancement (for example, seeing through fog or haze)
- Security: Counterfeit detection (such as for money, faked hair, or skin)