

- Ultra-compact (60.5 × 29 × 29 mm)
- Affordable
- PoE
- High frame rate

Small and powerful

Ultra-compact GigE Vision cameras

Mako G-050 with Sony ICX693 runs 71.2 frames per second at 0.5 MP resolution.

Mako is an attractively priced GigE Vision-compliant camera in a compact rugged industrial housing. Many models include advanced functionalities such as Precision Time Protocol (PTP), Trigger over Ethernet (ToE) Action Commands, and Power over Ethernet (PoE). Screw mount RJ45 connector and multiple I/Os facilitate your straightforward system integration. Mako cameras are also available as Near Infrared (NIR) and polarizer variants.

Easy software integration with Allied Vision's [Vimba Suite](#) and compatibility to the most popular [third party image-processing libraries](#).

See the [Modular Concept](#) for lens mount, housing variants, optical filters, case design, and other modular options. See the [Customization and OEM Solutions](#) webpage for additional options.

Specifications

Mako G-050	
Interface	IEEE 802.3 1000BASE-T, IEEE 802.3af (PoE)
Resolution	812 × 614
Sensor	Sony ICX693
Sensor type	CCD Progressive
Shutter mode	Global shutter
Sensor size	Type 1/3

Mako G-050	
Pixel size	6.0 μm \times 6.0 μm
Lens mounts (available)	C-Mount, CS-Mount
Max. frame rate at full resolution	71.2 fps
ADC	14 Bit
Image buffer (RAM)	64
Output	
Bit depth	8/12 Bit
Monochrome pixel formats	Mono8, Mono12, Mono12Packed
YUV color pixel formats	YUV411Packed, YUV422Packed, YUV444Packed
RGB color pixel formats	RGB8Packed, BGR8Packed
Raw pixel formats	BayerRG8, BayerRG12, BayerRG12Packed
General purpose inputs/outputs (GPIOs)	
Opto-isolated I/Os	1 input, 3 outputs
Operating conditions/dimensions	
Operating temperature	+5°C to +45°C (housing temperature)
Power requirements (DC)	10.8 to 26.4 VDC AUX or 802.3at Type 1 PoE
Power consumption	2.1 W at 12 VDC; 2.4 W PoE
Mass	80 g (with C-Mount)
Body dimensions (L \times W \times H in mm)	60.5 \times 29 \times 29 including connectors
Regulations	CE, RoHS, REACH, WEEE, FCC, ICES

Quantum efficiency

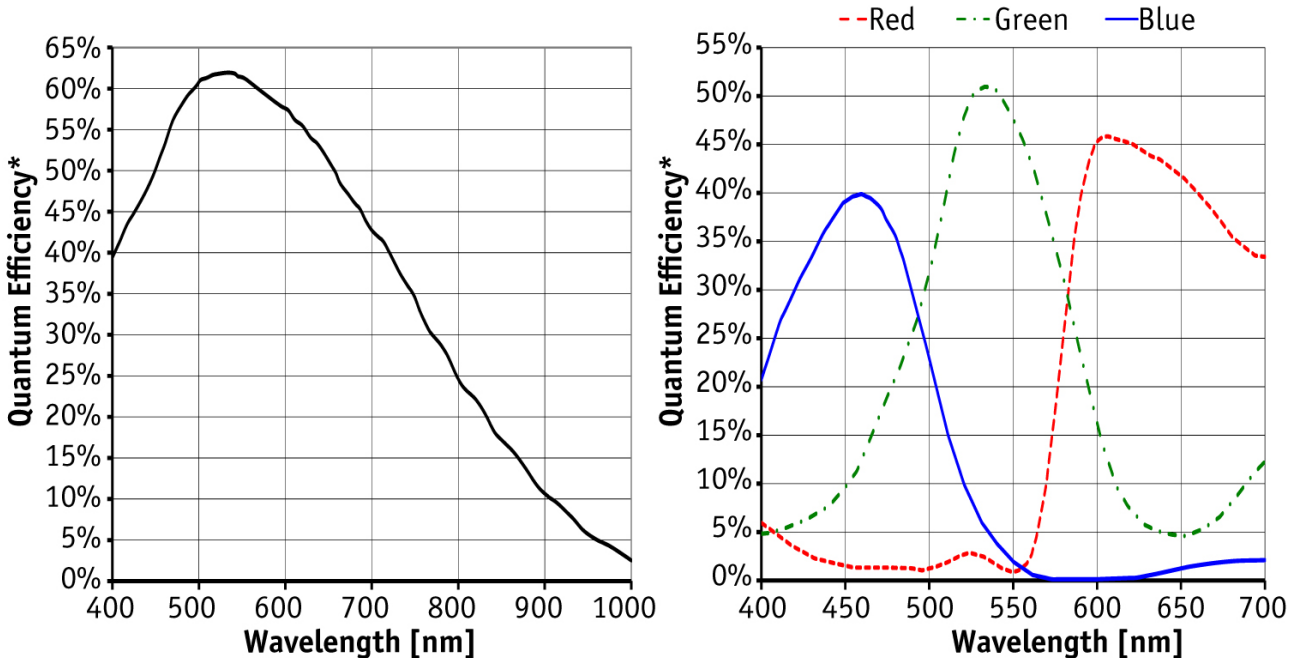

*QE measured without protection glass or filters. With glass or filters, quantum efficiency decreases by approximately 10%.

Features

- Camera temperature monitoring
- Region of Interest, separate region for auto features
- Binning
- Auto gain (manual gain control: 0 to 35 dB)
- Auto exposure (manual exposure control: 46 μ s to 84 s)
- Auto white balance
- Look-up table
- Gamma
- Hue, saturation, color correction
- StreamBytesPerSecond (easy bandwidth control)
- Stream hold
- Sync out modes: Trigger ready, input, exposing, readout, imaging, strobe, GPO
- Event channel

- Chunk data
- Storable user sets

Technical drawing

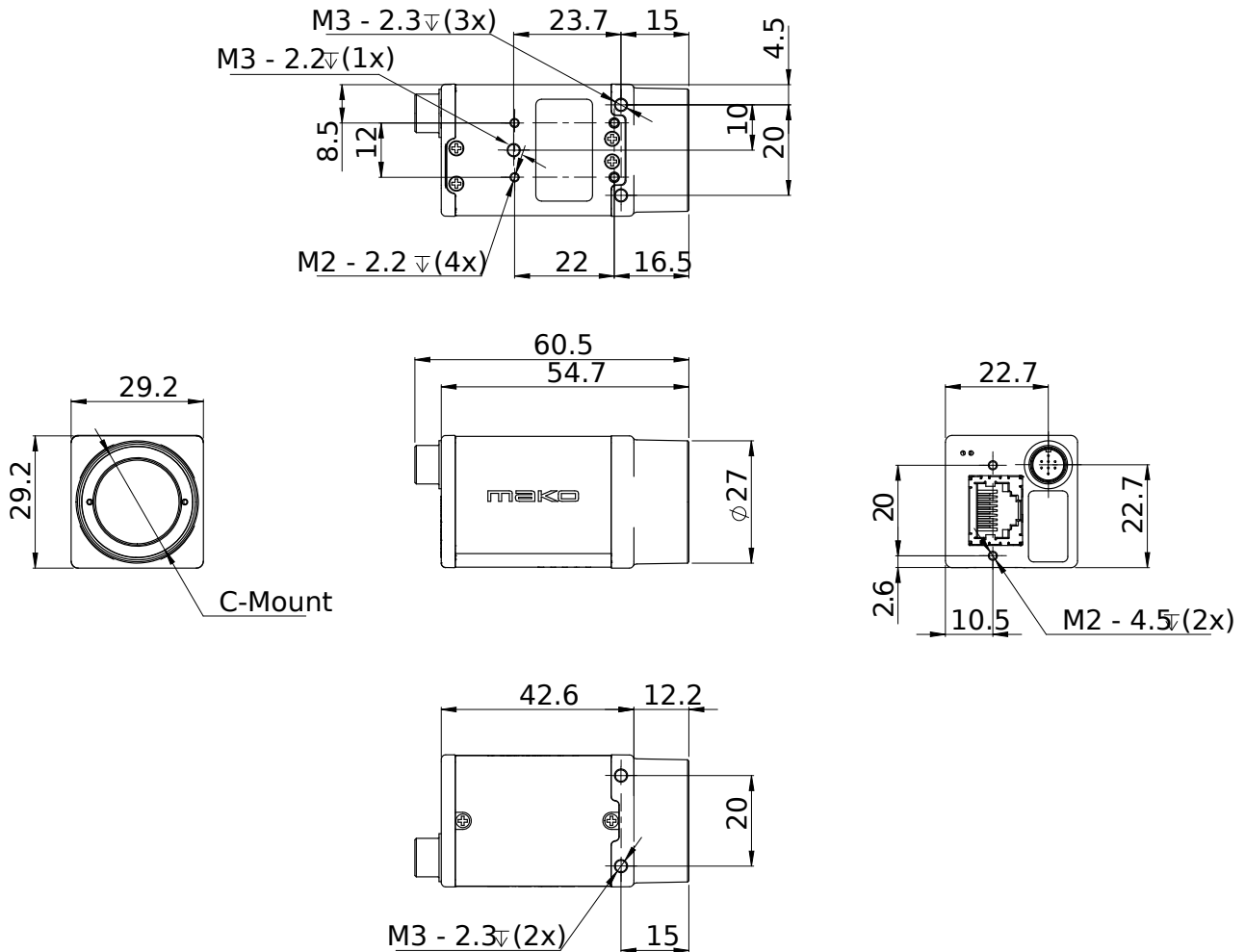

Applications

Mako G is an inexpensive industrial GigE camera with a compact form factor. It is suitable for all typical machine vision applications:

- Robotics
- Quality control
- Inspection, surveillance



- Industrial imaging
- Machine vision
- Logistics